

# Status of the Interoperability Projects under the 2014-2015 Calls

Member States Expert Sub-Group  
on the Integration of Maritime  
Surveillance and Security

Brussels, 07 July 2017

*Jesus Hermida*

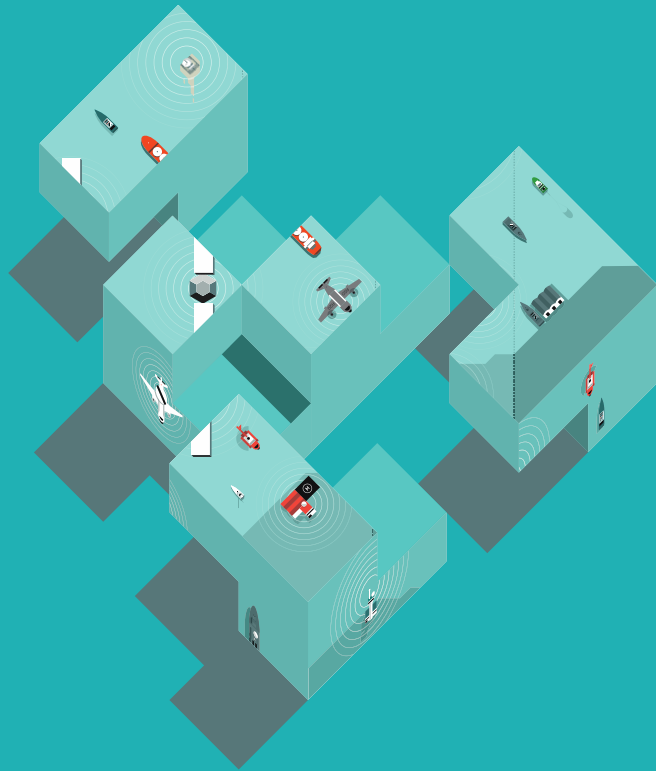

# Introduction

The Commission (DG MARE) launched annual calls for project proposals opened to national authorities

- Under the European Maritime and Fisheries Fund (EMFF) for 2014-2020
- Budget set aside to support the integration of maritime surveillance at national level and across MS
- Managed by EASME *Executive Agency for Small and Medium-sized Enterprises*

Objective: To foster the information exchange across sectors and borders by supporting the improvement of IT interoperability between national authorities' systems

# Calls for Projects

## 2014 Call (4,590,000 EUR)

- 7 projects (ES, FI, GR, PT, RO)
- 1-2 years
- From Jan 2016 to Dec 2017

## 2015 Call (2,538,000 EUR)

- 3 projects (BG, CY, ES, GR)
- 1-2 years
- From Jan 2017 to Dec 2018

## 2016-2017 Call (2,490,000 EUR)

- Proposals under evaluation
- Projects will start in Jan 2018 until Dec 2019

# MS in EUCISE2020

MS participating in EUCISE2020

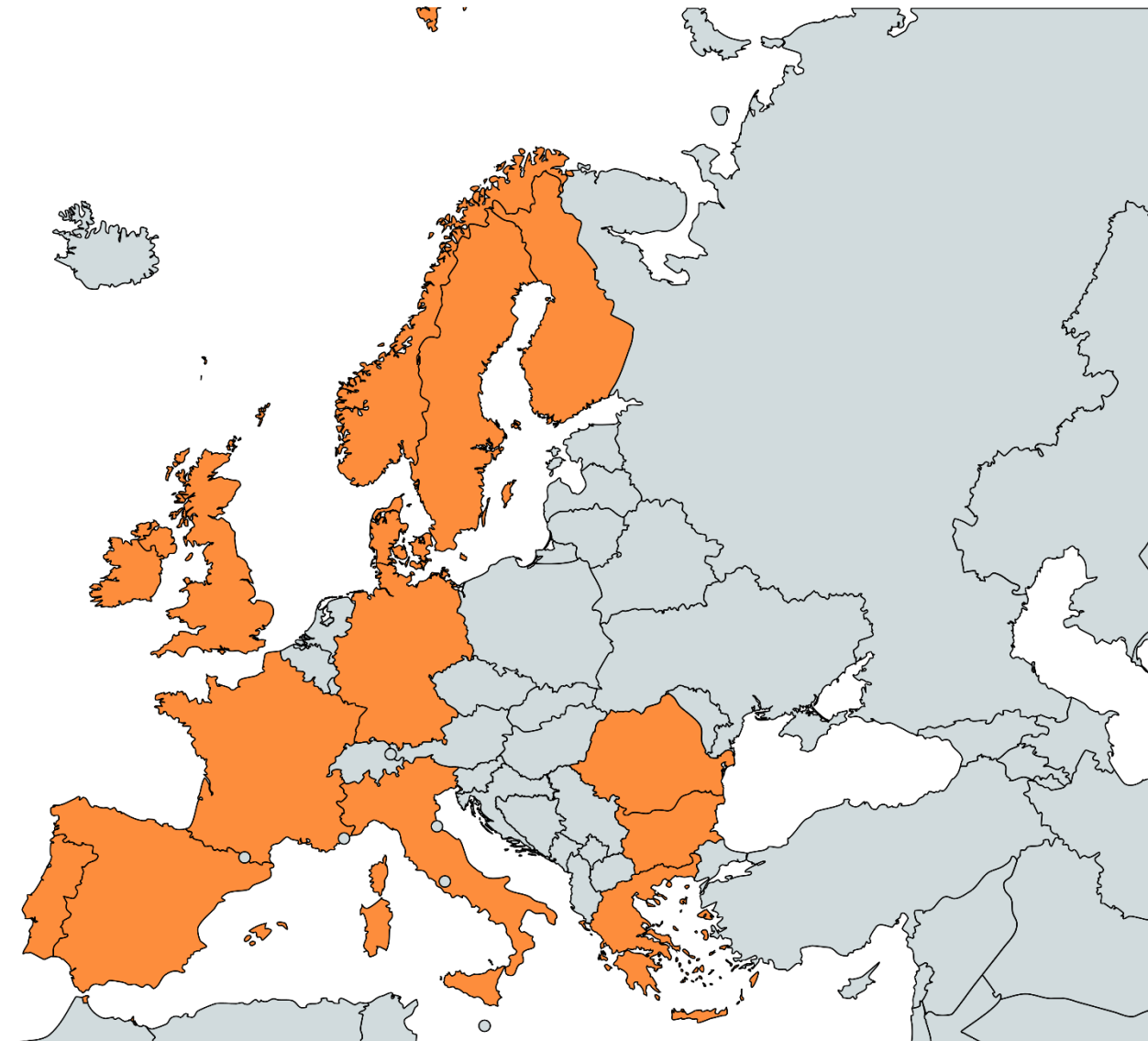

Created with mapchart.net ©

# MS with Interop Projects

- MS involved in the 2014 Call
- MS involved in the 2015 Call
- MS involved in both calls

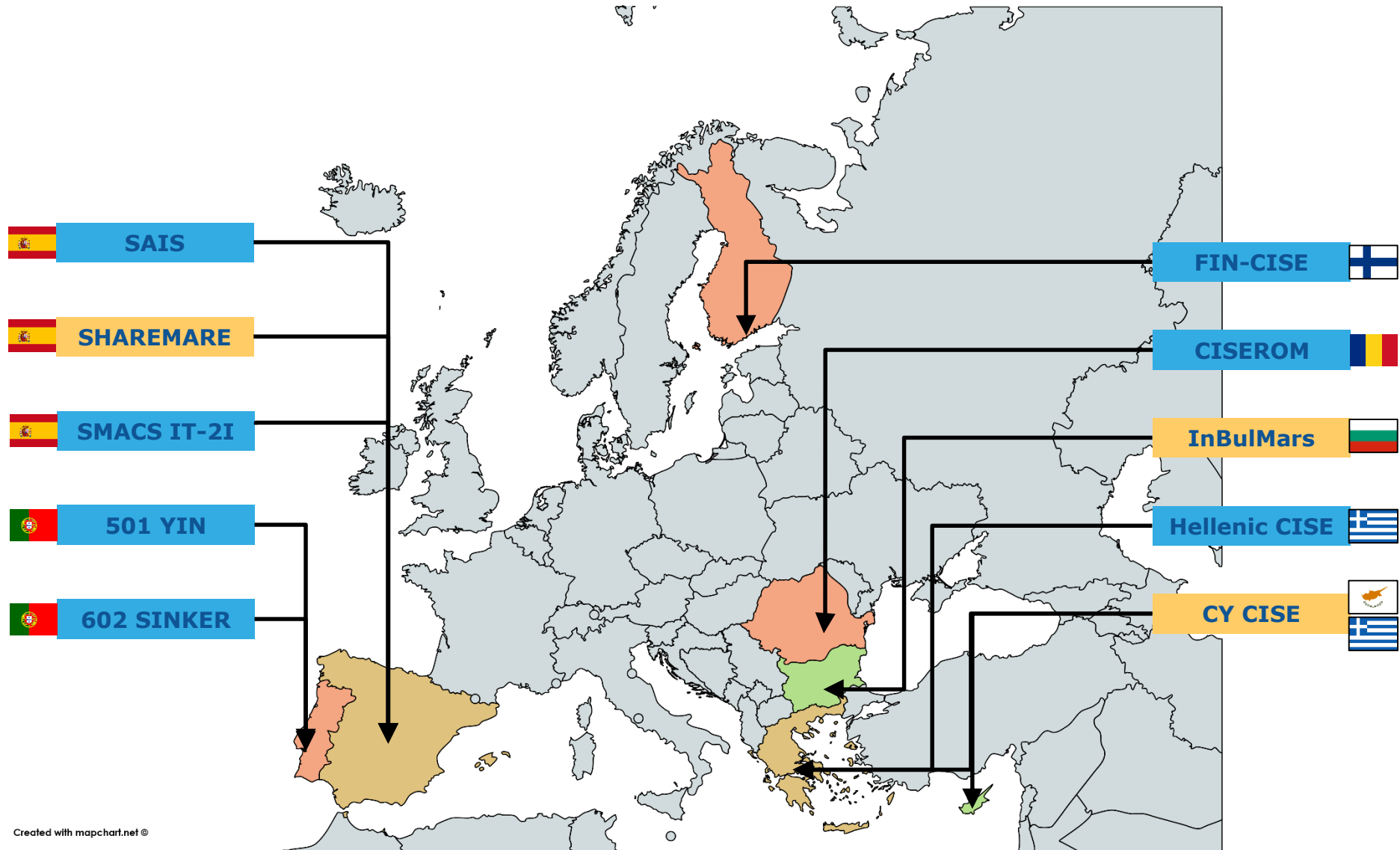

Created with mapchart.net ©

# Schedule

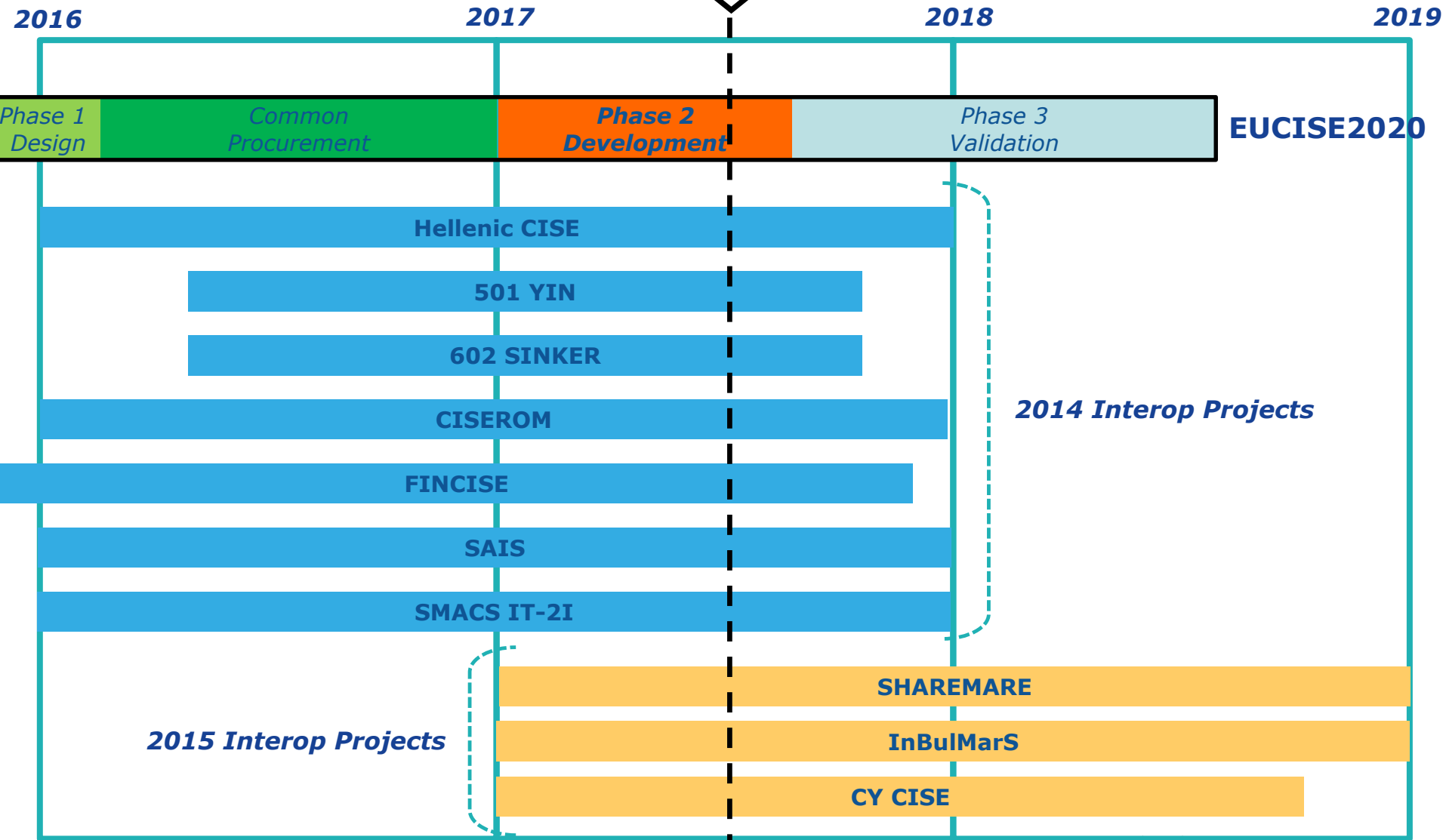
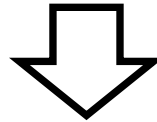

# 2014 Interop Projects

- **Hellenic CISE** (study + IT developments)
- **501 YIN** (study)
- **602 SINKER** (IT developments)
- **CISEROM** (study)
- **FINCISE** (study + IT developments)
- **SAIS** (study + IT developments)
- **SMACS** (study + IT developments)

# Hellenic CISE (GR) 01 Jan 2016 – 31 Dec 2017

- Existing system
- Developed by the project
- Developed by EUCISE 2020
- Future developments



Hellenic Ministry of Defence  
(Navy)



Hellenic Coast Guard



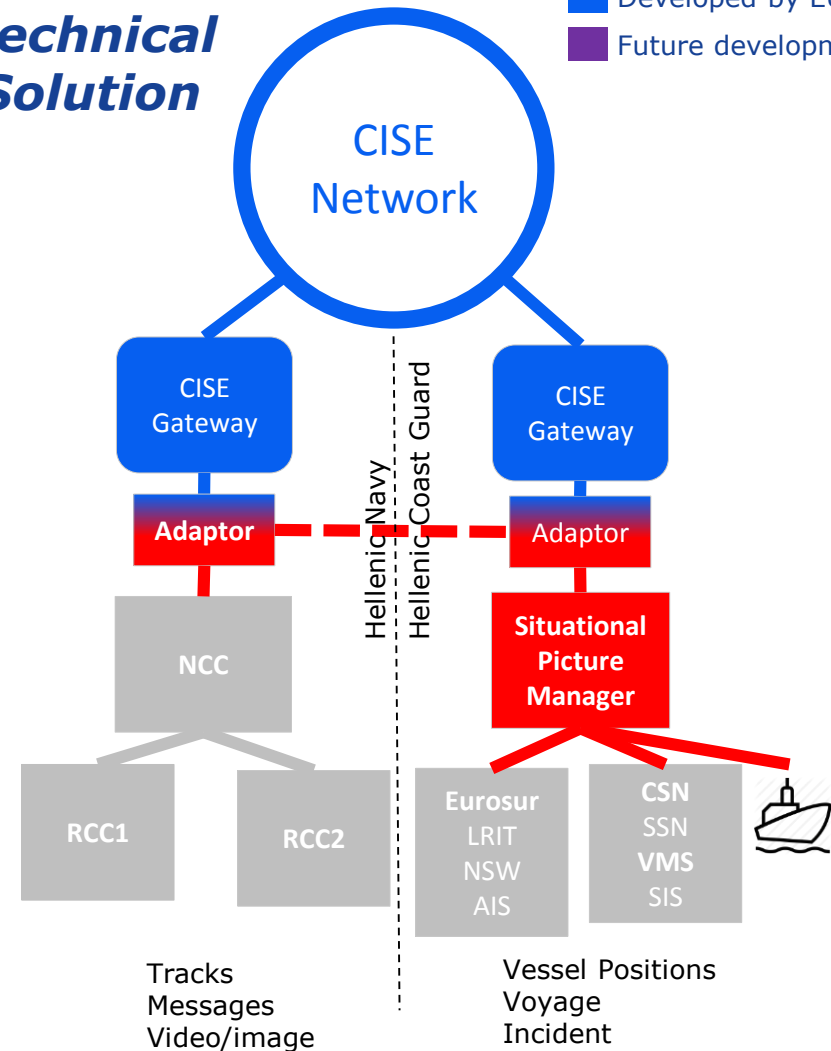

National Centre of Scientific  
Research "Demokritos"

## Technical Solution



## Studies

-  Analysis and identification of user needs
-  IT Transformation plan
-  Communication plan



# 501 YIN (PT) 01 Apr 2016 – 31 Oct 2017

13 authorities



Directorate General for  
Maritime Policy

- Tax and Customs Authority
- Maritime Authority Directorate-General
- Directorate-General of Natural Resources, Safety and Maritime Services
- Directorate-General of Territorial Development
- Portuguese Air Force
- National Republican Guard
- Portuguese Maritime Casualty Prevention and Investigation Office
- Portuguese Sea and Atmosphere Institute
- Portuguese Navy
- Criminal Investigation Police
- Maritime Police
- Portuguese Security Intelligence Service

## Studies



Study on the existing legal framework + Legal Handbook



Requirements for NIPIM@R



Study on Information Gaps + Cost-Benefit analysis



Videos + communication material



National Action Plan for maritime surveillance information sharing

## Technical Solution (Planned)

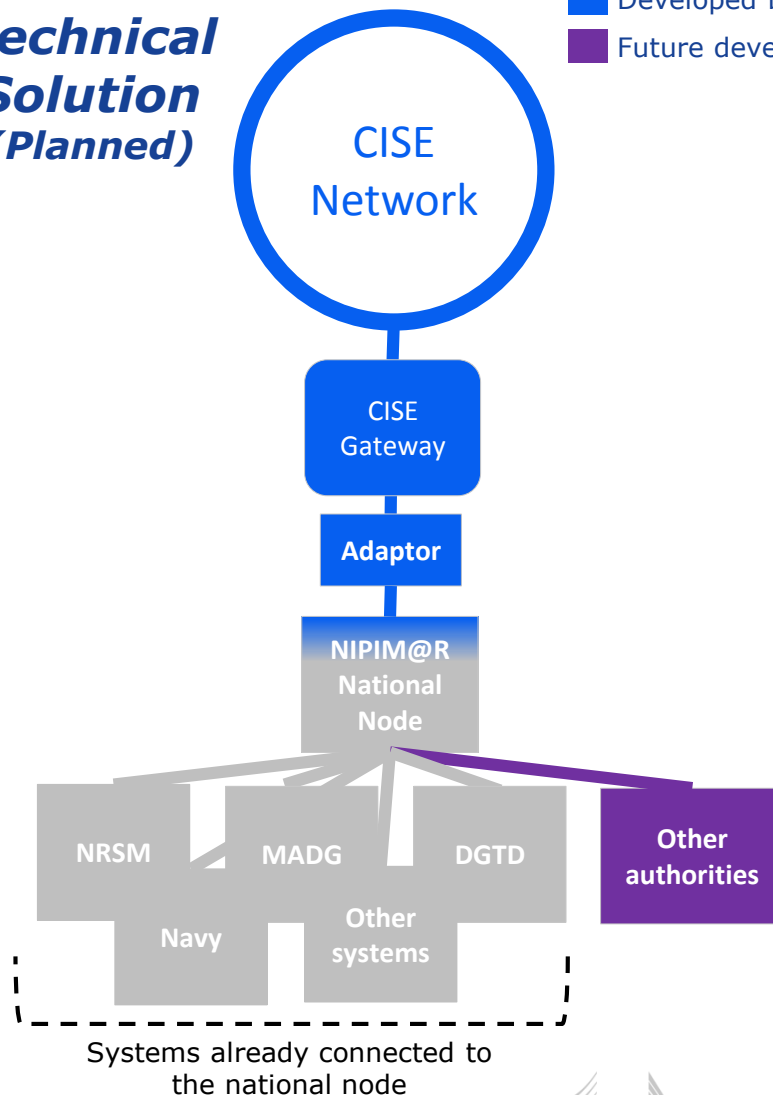

- Existing system
- Developed by the project
- Developed by EUCISE 2020
- Future developments



European  
Commission

# 602 SINKER (PT) 01 Apr 2016 – 31 Oct 2017

7 authorities



Directorate General for Maritime Policy

- Directorate General of Natural Resources, Safety and Marine Services
- Maritime Authority Directorate General
- Directorate General for Territorial Development
- Portuguese Navy
- Criminal Investigation Police
- Portuguese Security Intelligence Service.

## Studies



Service specification documents



Requirement documents



Validation reports

## Technical Solution

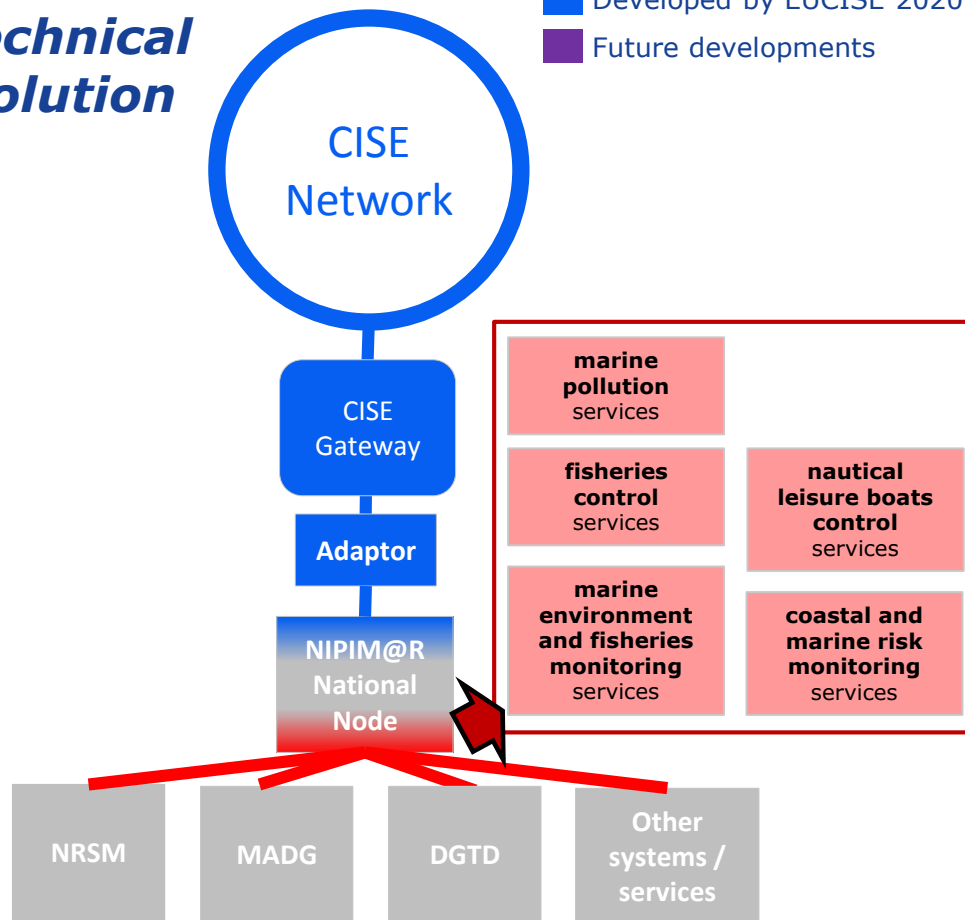

# CISEROM (RO) 01 Jan 2016 – 31 Dec 2017

- Existing system
- Developed by the project
- Developed by EUCISE 2020
- Future developments



General Inspectorate of the Romanian Border Police



Romanian Naval Authority



National Agency for Fishery and Aquaculture

## Studies



Terms of Reference for the Feasibility study



Feasibility Study for the development of the national node

- Stakeholders matrix
- Requirements
- Analysis of the possible solutions
- Technical specifications

## Technical Solution (Future)

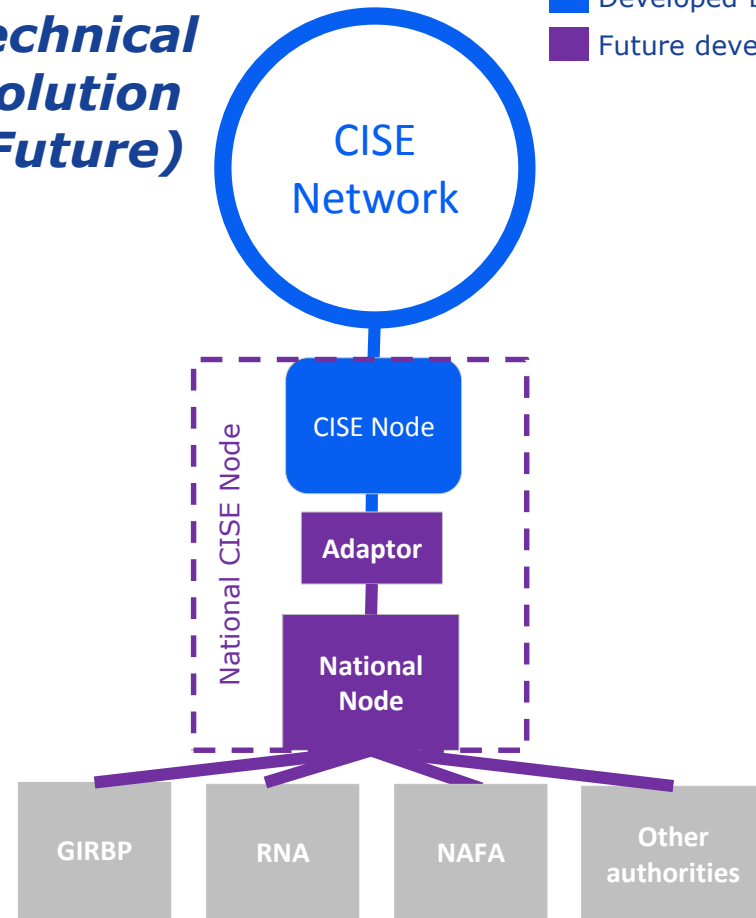

# FINCISE (FI) 01 Dec 2015 – 30 Nov 2017

- Existing system
- Developed by the project
- Developed by EUCISE 2020
- Future developments

Finnish Border Guard

Finnish Transport Agency

Finnish Transport Safety Agency

Finnish Navy

Finnish Environment Institute

## Technical Solution

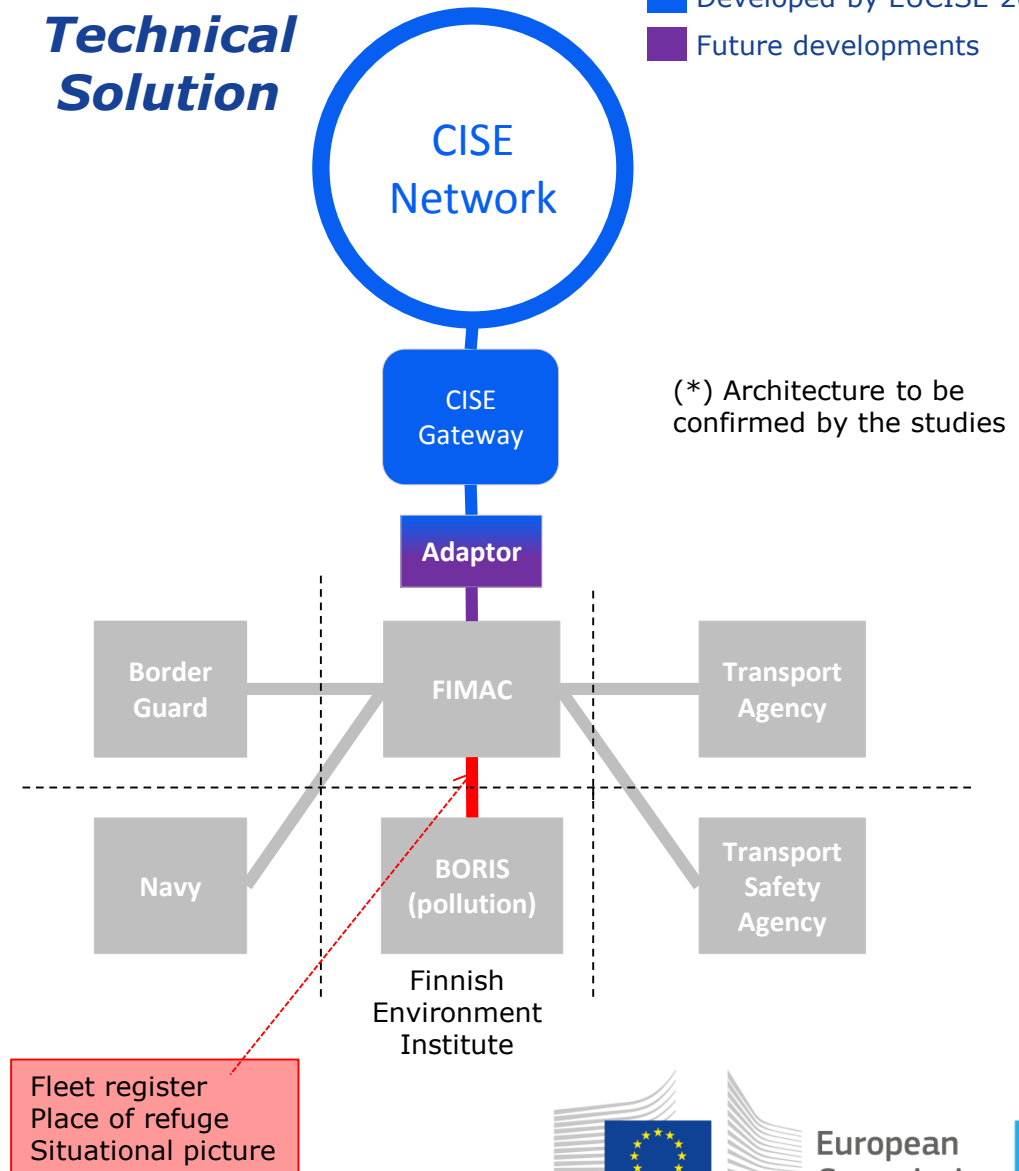

## Studies

- Architecture for different situation pictures
- Data and information service catalogue
- Roadmap towards CISE

# SAIS (ES) 01 Jan 2016 – 31 Dec 2017



Guardia Civil

## Studies

 Analysis and identification of user needs

 Technical specifications

 Communication plan

## Technical Solution

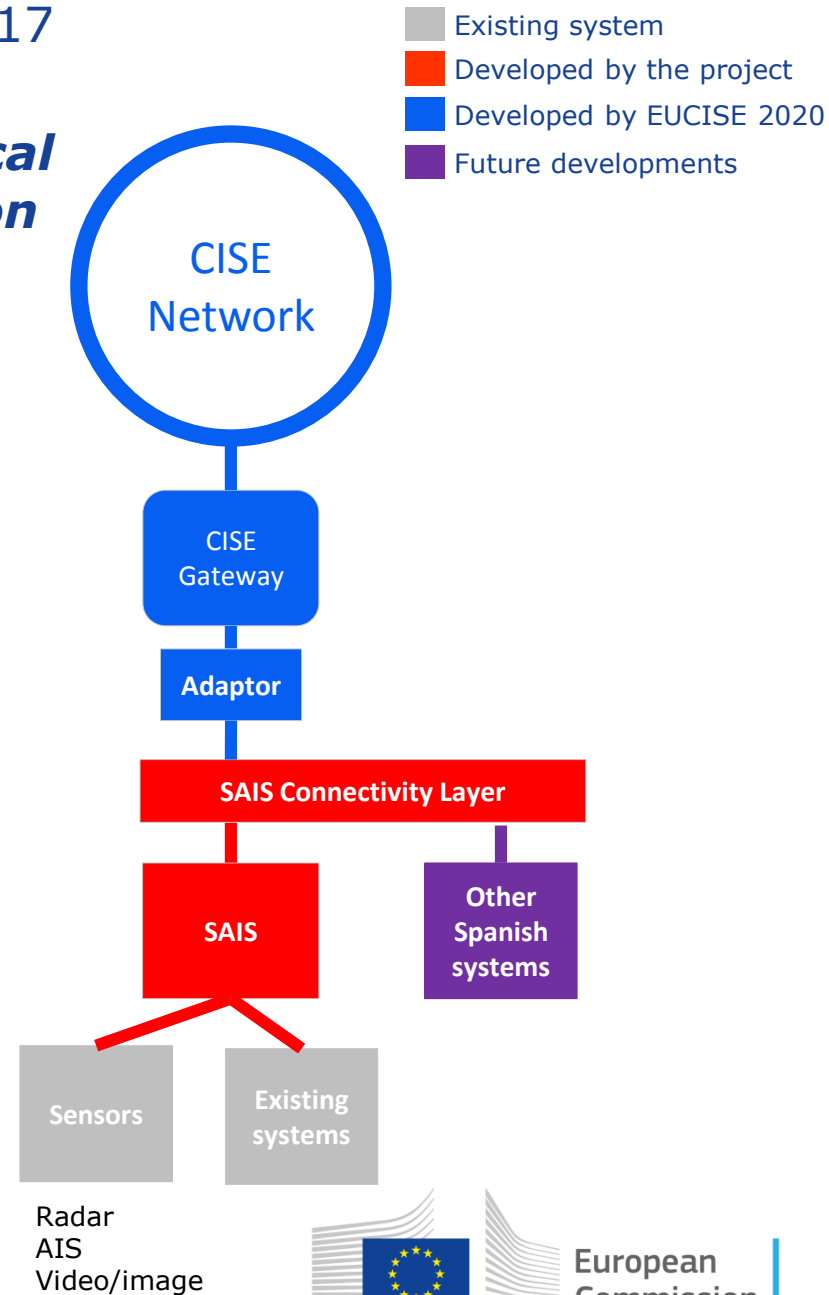

# SMACS IT-2I (ES) 15 Jan 2016 – 15 Jan 2018

- Existing system
- Developed by the project
- Developed by EUCISE 2020
- Future developments



Spanish Navy



Spanish Tax Agency and Customs Department



Secretariat General of Fisheries – Section on Fisheries Control and Inspection (SEGEPESCA)

## Studies



Technical specifications



System requirements specifications

## Technical Solution

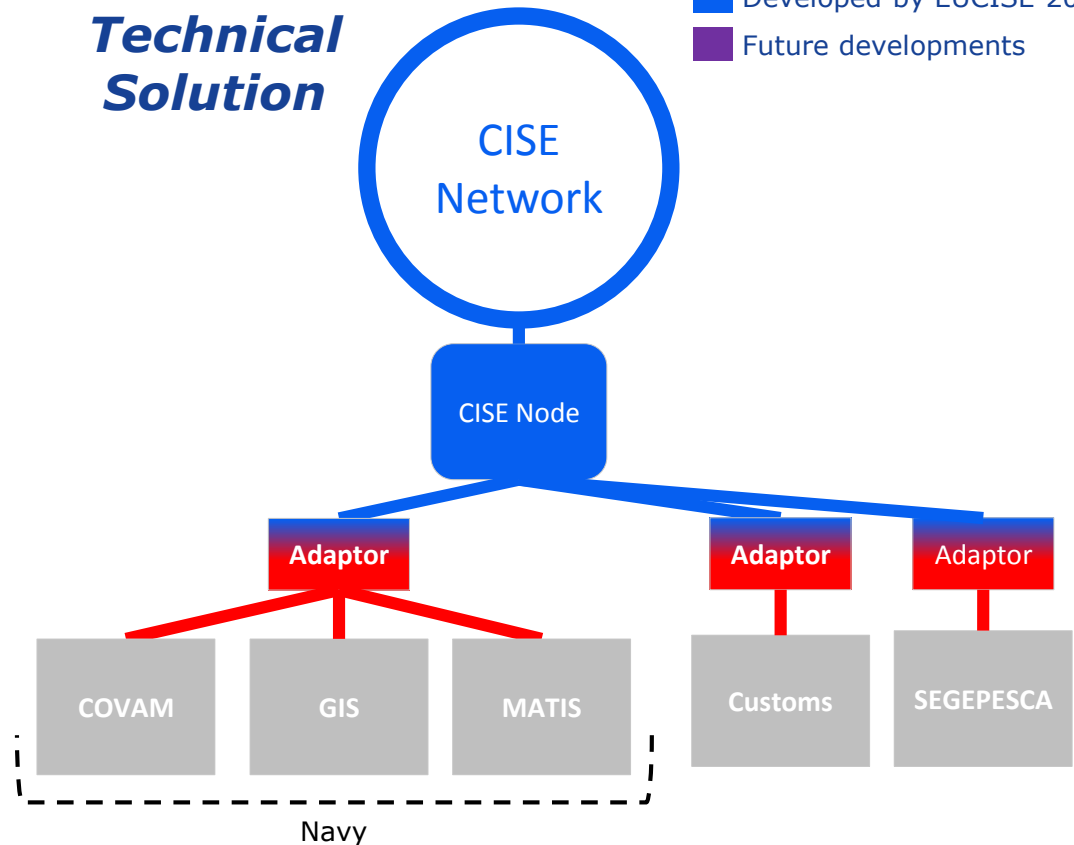

Each partner will manage a different adaptor in the same CISE Node.

# 2015 Interop Projects

- **SHAREMARE** (study + IT developments)
- **CY CISE** (study + IT developments)
- **InBulMarS** (study)

# SHAREMARE (ES) 01 Jan 2017 – 31 Dec 2018

- Existing system
- Developed by the project
- Developed by EUCISE 2020
- Future developments



Guardia Civil

Spanish Search and Rescue Agency (SASEMAR)

Puertos del Estado  
National Ports Agency (OPPE)

Secretariat General of Fisheries  
– Section on Fisheries Control  
and Inspection (SEGEPESCA)

## Technical Solution

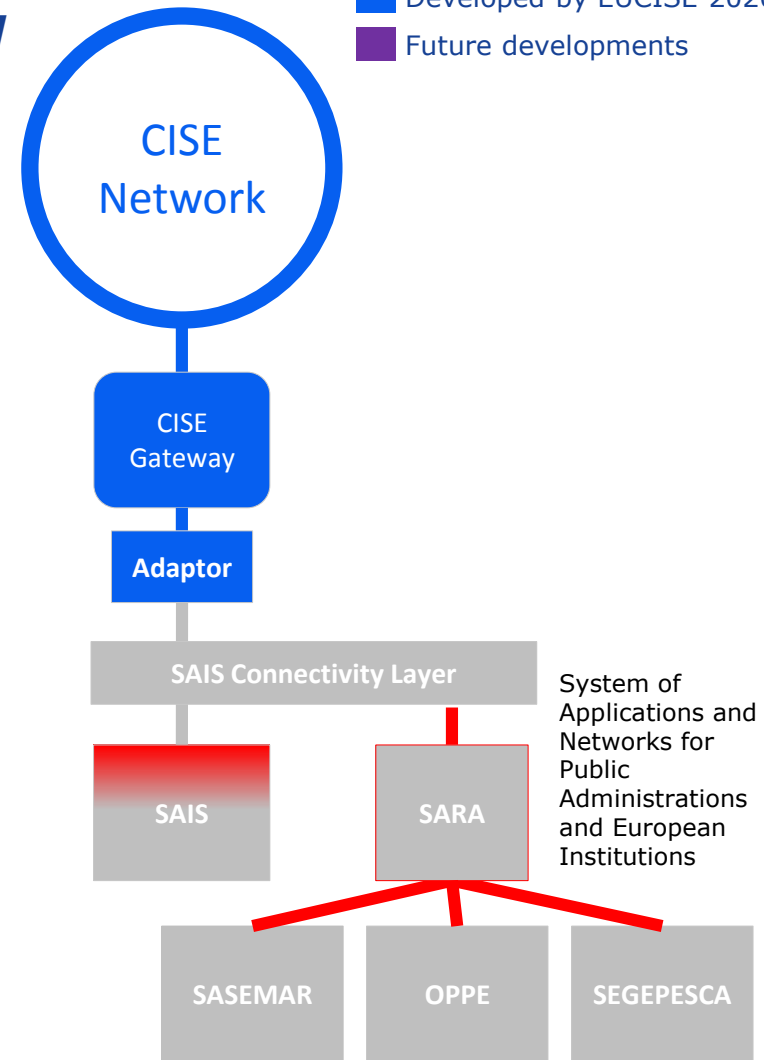

## Studies

- Analysis and identification of user needs on information sharing
- Identification of the available systems
- Technical specifications / validation strategy



# CYCISE (CY+GR) 01 Jan 2017 – 31 Oct 2018

- Existing system
- Developed by the project
- Developed by EUCISE 2020
- Future developments



National Centre of Scientific Research "Demokritos" (GR)



Department of Merchant Shipping (CY)



Hellenic Ministry of Defense



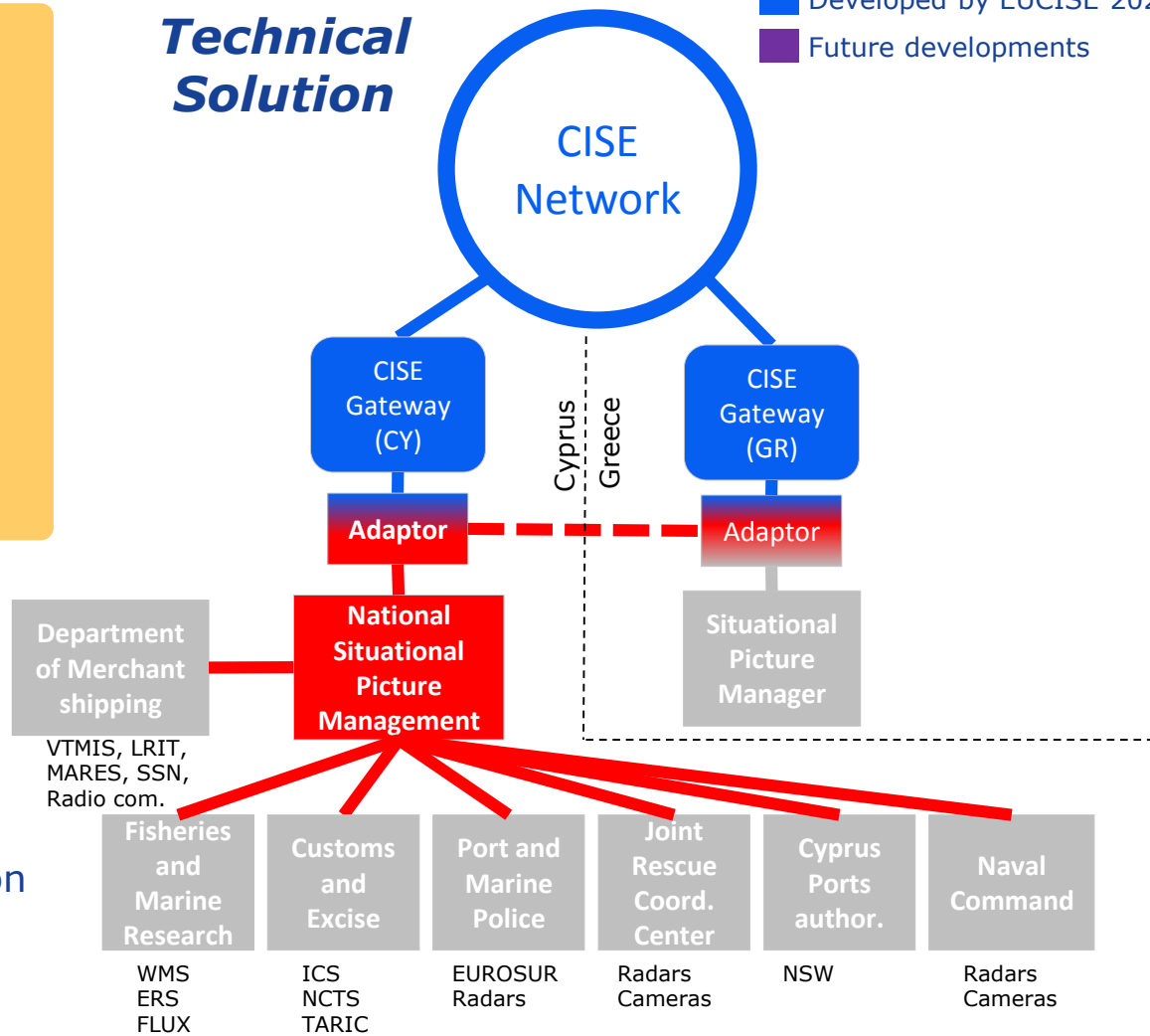

KIOS research centre (CY)

## Technical Solution



## Studies

-  User need study (cross-border)
-  Definition of new information study
-  System specifications

# InBulMarS (BG) 01 Jan 2017 – 31 Dec 2018

- Existing system
- Developed by the project
- Developed by EUCISE 2020
- Future developments

Bulgarian Maritime Administration

National Customs Agency

Bulgarian Navy



Bulgarian Ports Infrastructure Company (BPI)

National Agency for Fisheries and Aquaculture

## Technical Solution (not yet decided)

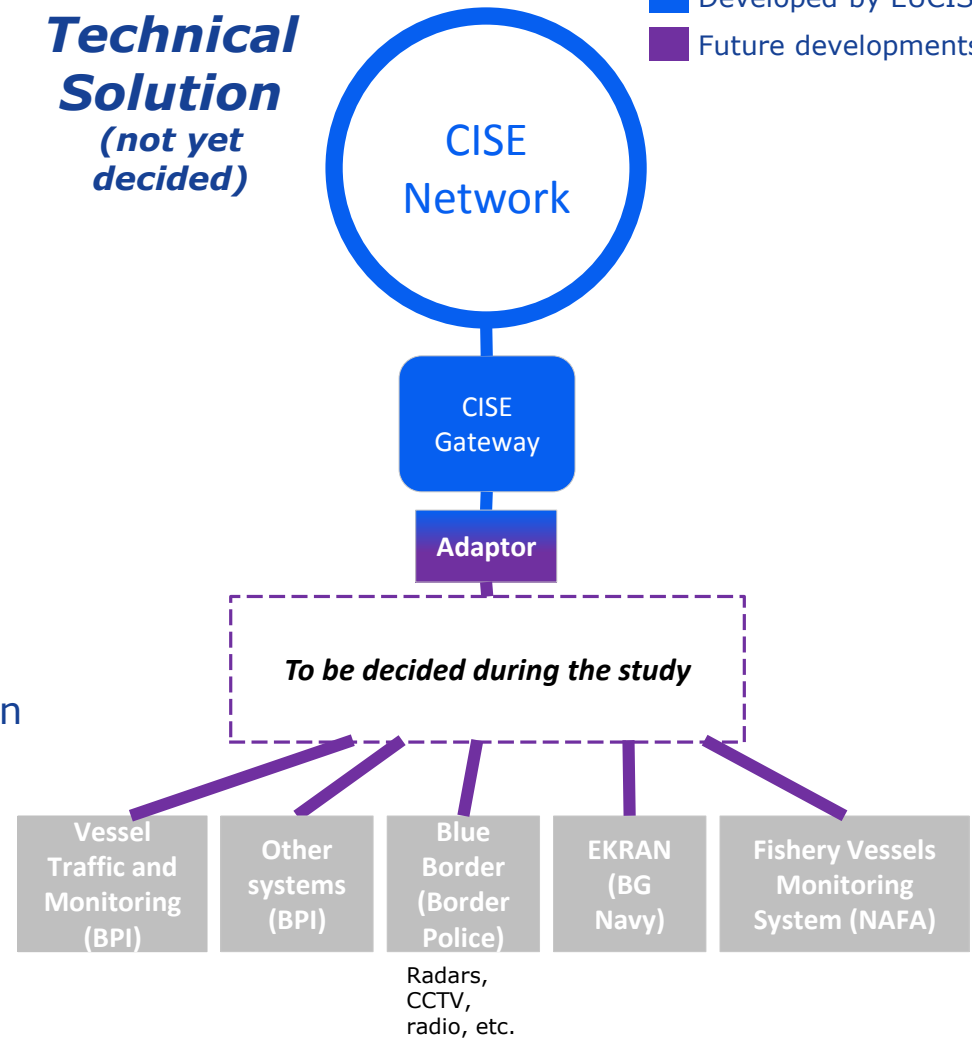

## Studies



Analysis of the existing information systems carrying out surveillance and intervention at sea



Legal analysis



Requirements and tech specs for future developments

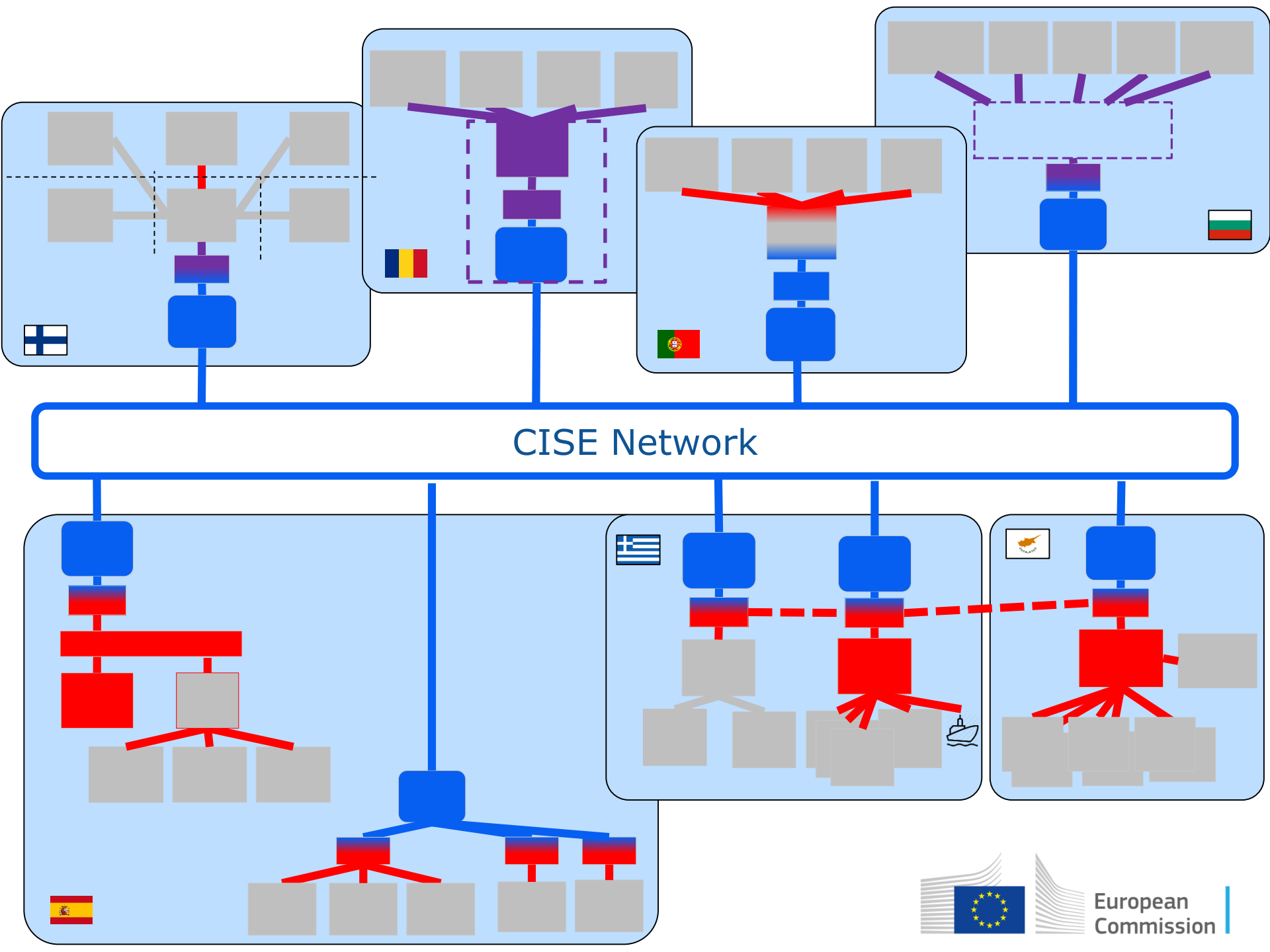

# Thank You!

*For more information:*



**Maritime Forum:** <https://webgate.ec.europa.eu/maritimeforum/en/cise>



Twitter: **@EU\_ScienceHub, @EU\_MARE, #EUCISE2020**



YouTube: **<https://www.youtube.com/watch?v=EDkexwhVUVE>**



**Soon :)**