

Integrated End-to-End and Fisheries Bio-Economic Modeling for Evaluating Ecosystem-Wide Effects of Human Pressures in the Baltic Sea

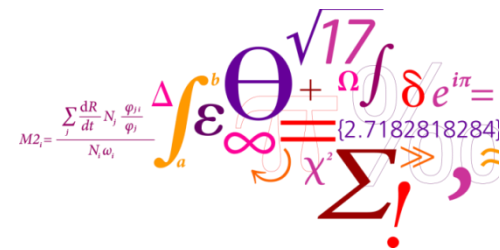

J. Rasmus Nielsen, Artur Palacz, Sieme Bossier,
 Francois Bastardie, Asbjørn Christensen, Kerstin Geitner
 and Elisabeth A. Fulton.



Key Biological Data and Monitoring: Marine Higher Trophic Levels - Fish and Fisheries



ICES (International Council for Exploration of the Sea) Biological Data:
Sampling from Member National Institutes

Dataset	Measurements	No of years
Biological community	832 193	35
Contaminants and biological effects	11 666 819	38
Eggs and Larvae	1 010 599	93
Fish predation (stomach contents)	1 149 608	12
Fish trawl surveys	6 565 612	51
ICES Historical Plankton	318 319	11
Oceanographic	285 608 302	127

Key Fish, Shellfish & Fisheries Monitoring and Data: EU DCF & ICES



At Sea Observer
Sampling
Commercial Fishery

Harbor Sampling
Commercial
Fishery

VMS Data by
vessel, trip & haul
(fishing+steaming)

Self Sampling
Commercial
Fishery

**Catch, Effort, Biological &
Economic Data by species,
fleet, vessel, trip & haul**

Fisheries Economic
Data by vessel & trip



Fish & Shellfish Trawl
+ Dredge + Gillnet
Surveys by haul or set



Fish Acoustic +
Video Surveys
(cont. transects)

Fish Plankton +
Hydrographic Surveys



The problem and challenge

Human-induced changes in the heavy-populated Baltic Sea catchment area.

To evaluate biological and economic effects of single and multiple pressures:

- Nutrient loads / Eutrophication
- Climate change
- Fishery

on the semi-enclosed Baltic Sea ecosystem in relation to existing and anticipated management plans (EU Directives) under Ecosystem Based Management.

The Approach

To modify and use a holistic modeling tools capable of simulating the likely structural and functional ecosystem responses to pressures as well as the consequences for ecosystem goods and services, e.g. fisheries impacts and responses.



Sieme Bossier

Gratiske Ressourcen

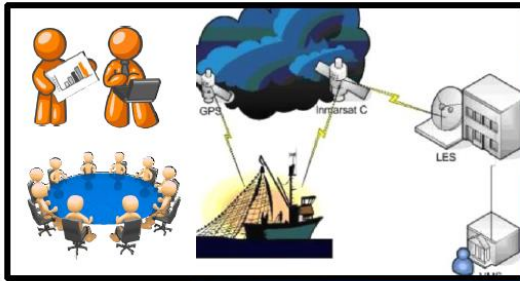

management



Beth Fulton



socio-economics & fleet-based bio-economics



J. Rasmus Nielsen



Artur Palacz

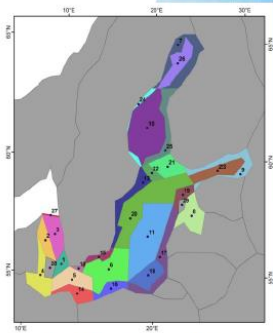

model domain

Baltic ATLANTIS model

marine foodweb & benthic-pelagic coupling

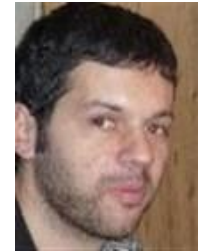

François Bastardie



Kerstin Geitner

physical hydrodynamic & bio-geochemical conditions (HBM-ERGOM)

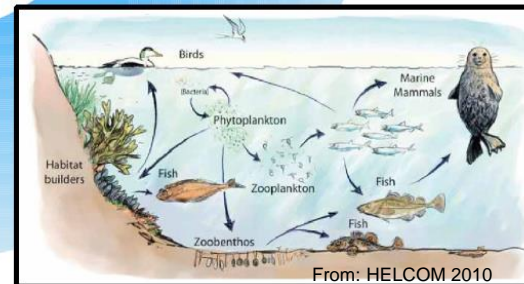
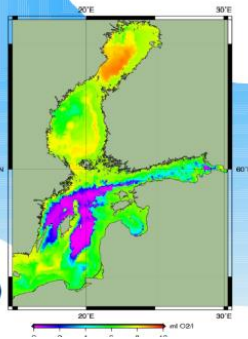

From: HELCOM 2010



Asbjørn Christensen



Marie Maar

Baltic Atlantis Implementation: geometry & forcing

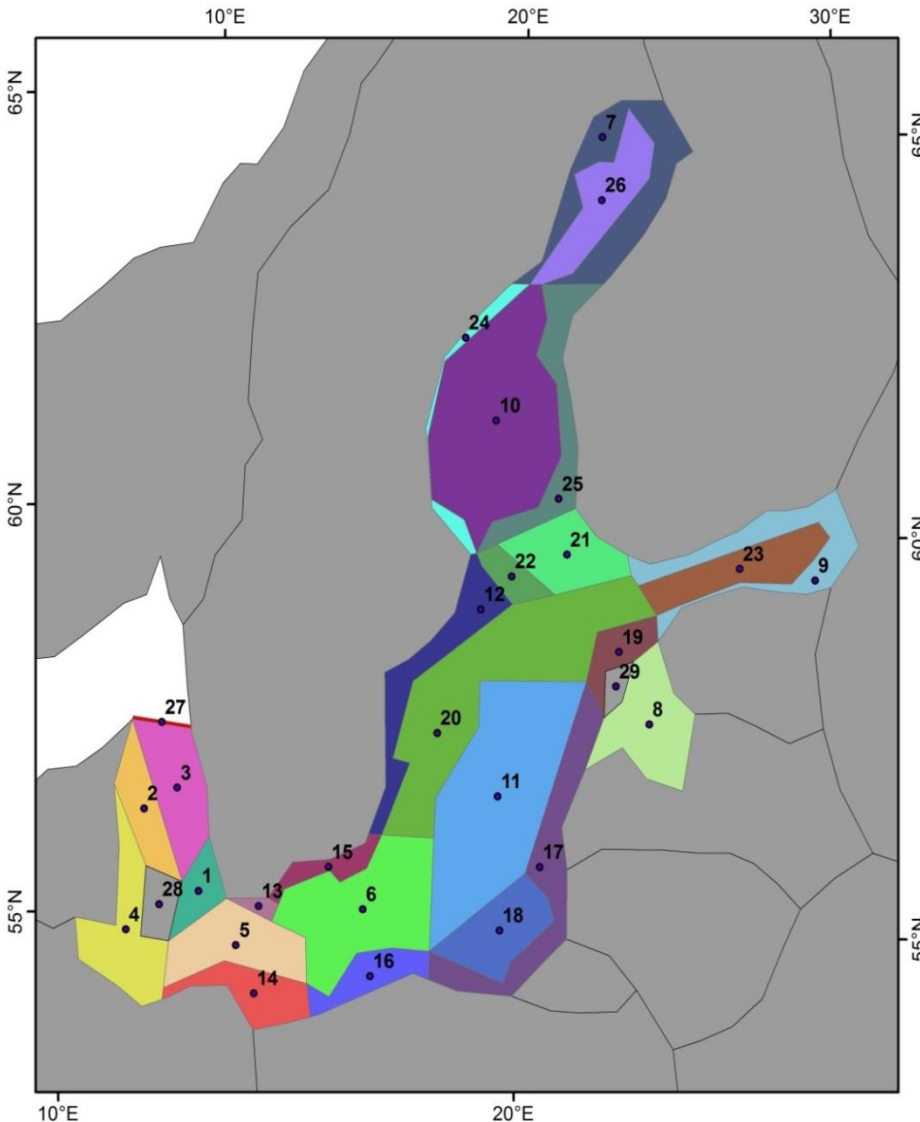

Geometric structure:

- 29 polygons
- 26 dynamic boxes, 3 boundary boxes
- 9 vertical layers

Forcing & initial conditions:

- HBM-ERGOM (or RCO-SCOBI) -> Each ATLANTIS Polygon
- Initial conditions 2005 with new hindcasting
- Temperature, salinity, nutrients, volume exchange
- Point source inputs of Nitrogen (box uniform) (by country data from HELCOM PLC-5.5: 5th Baltic Sea Pollution Load Compilation)

Time resolution:

- Year & Quarter & Month & Age

ATLANTIS implementation: Biological model input groups & habitats

33 Biological functional groups

- **Marine mammals (2)**
- **Seabirds (2)**
- **Fish (9): cod, sprat, herring, whiting, flatfish, cyprinids, mall demersals, small pelagics, perch-like fish.**
- **Benthic invertebrates (7)**
- **Benthic flora (3)**
- **Zooplankton (4)**
- **Phytoplankton (3)**
- **Detritus (3)**

Vertebrates age structured & mature / juvenile

Invertebrates: 1 biomass pool, except Nephrops structured to mature/juvenile

Data sources: Nutrients, Sediments, Habitats, Plankton, Benthos, Fish, etc.
(including invertebrate and vertebrate life history parameters)

- HBM-ERGOM: physics & nutrients & plankton
- HELCOM Pollution Load Compilation 5.5: point sources - N point sources)
- HELCOM: Habitat distribution based on HELCOM sediment classes (EUNIS, EMODNET data)
- ICES Fish Stock Assessments: fish stock biomass by age, age-length keys
- ICES BITS & Acoustic Surveys: fish relative spatial distribution and abundance by age
- HELCOM: Abundance indices for Freshwater Species (by age)
- ICES, DMU, SMHI, HERTTA* databases: invertebrate abundance/biomass
- Literature: biological & chemical rates, diets, life history traits etc.

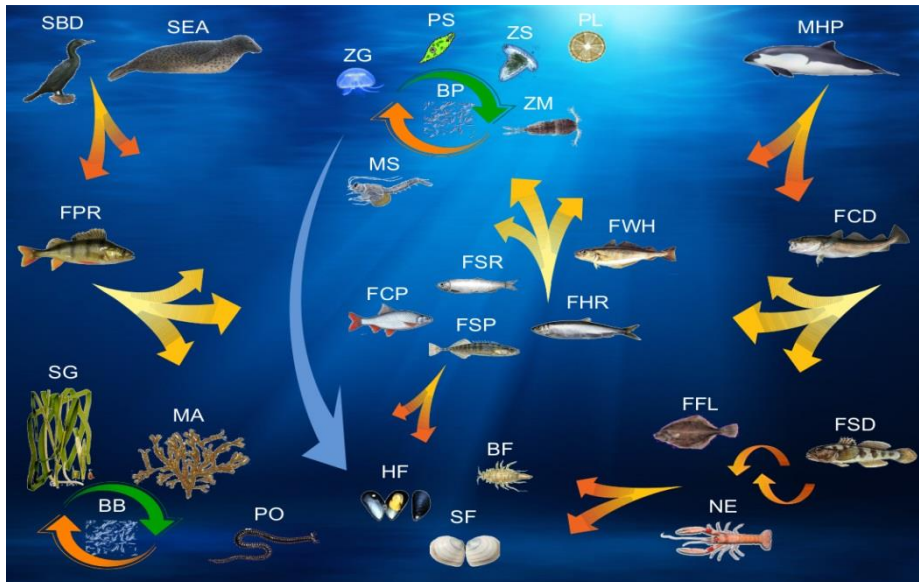

Model is calibrated to simulate a balanced ecosystem in \sim equilibrium state under the 2005 initial conditions

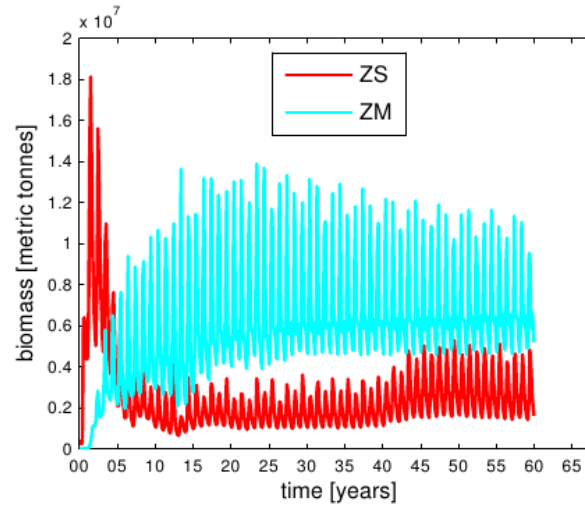
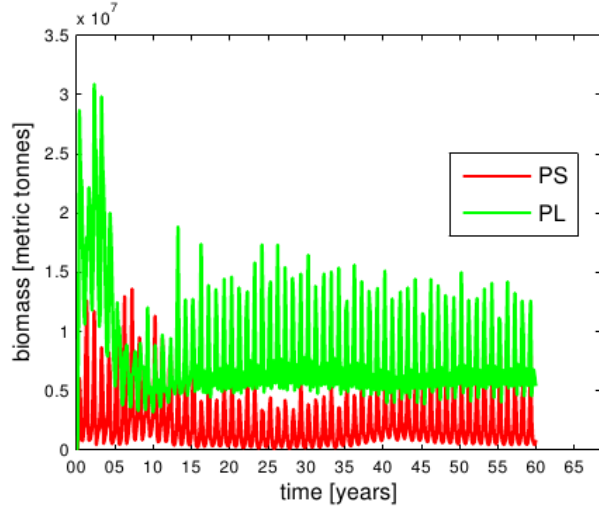

Phytoplankton:
PS – small phytoplankton
PL – large phytoplankton

Zooplankton:
ZS – microzooplankton
ZM – mesozooplankton

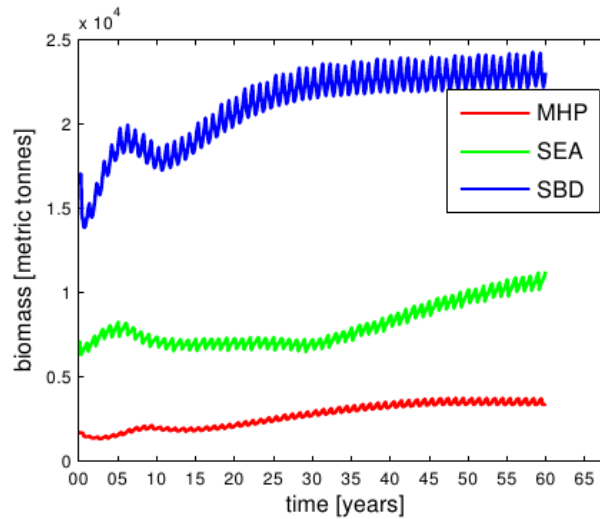
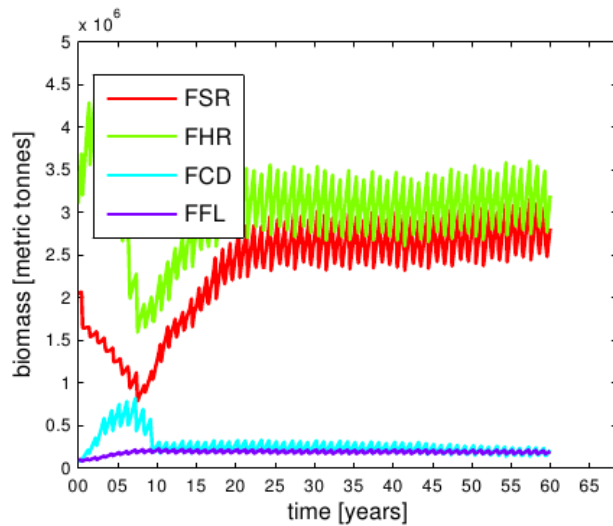

Fish:
FSR – sprat
FHR – herring
FCD – cod
FFL – flat fish

Higher Trophic Levels:
MHP – harbour porpoise
SEA – seals
SBD – pursuit-diving seabirds

Figure 1: Selected time series of area-integrated biomass in metric tonnes from a 60-year model spin-up run. (Phytoplankton, zooplankton, fish and higher trophic levels groups).

Model verification

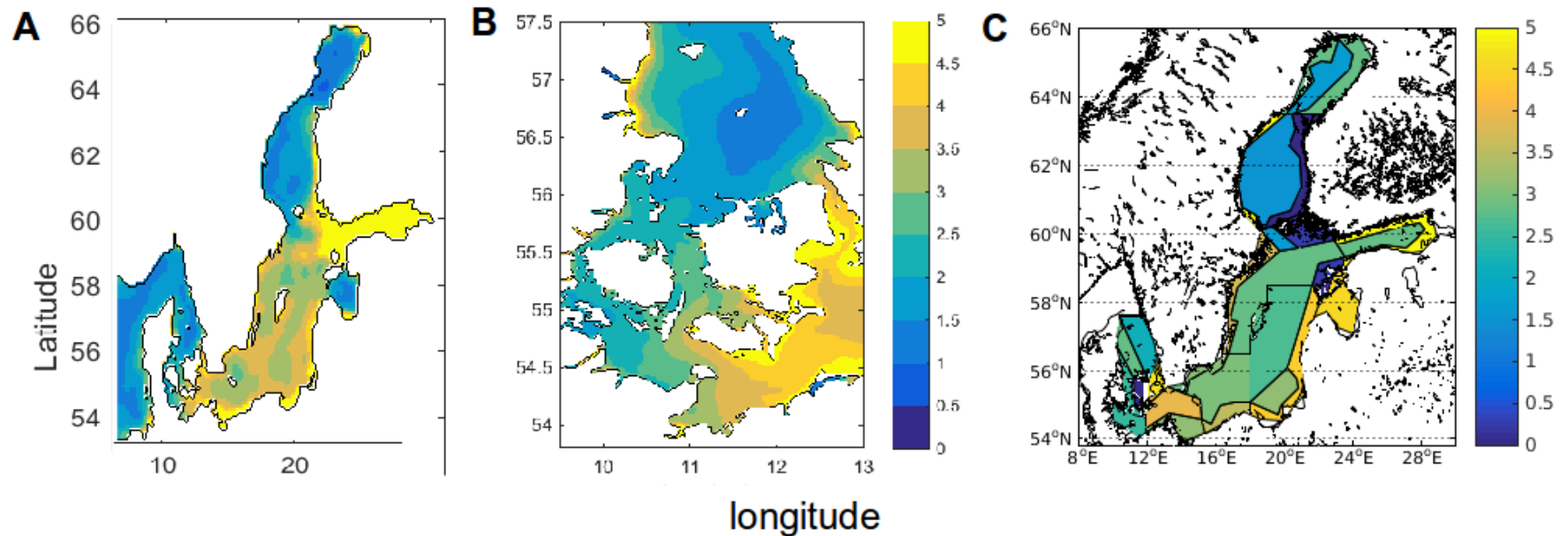

Figure 2: Spatial distribution of annual average surface chl-a as simulated by HBM-ERGOM (A-B) and Baltic Atlantis (C).

Integrated eutrophication scenario evaluation:



In Baltic Atlantis 3 nutrient load reduction scenarios are applied with the same new forcing repeated for 20 years forecast to bring the system to new near-equilibrium:

- **Scenario 1:** Reduction of single country nutrient loads: 33% reduction of Danish contribution to N river load in Kattegat, the Sound and Western Baltic areas.
- **Scenario 2:** Reduction of single countries nutrient loads: 33% reduction on DK+SWE+GER N river loads in those areas.
- **Scenario 3:** Nutrient reductions in all Baltic states: Projected Baltic-wide point source reductions to match BSAP2 (Baltic Sea Action Plan 2) demands.

Integrated eutrophication scenario evaluation: the Baltic Atlantis

Long term biomass changes (%)			
Species	Scenario 2	Scenario 3	Scenario 4
COD_KA	-0.5	-1.4	-0.4
COD_WB	-0.3	-1.1	-1.0
SPR_KAWB	-1.58	-3.20	-3.60
HER_KAWB	-1.45	-3.68	-3.58
WHI_KAWB	-3.10	-4.33	-2.20
FLAT_KAWB	-0.95	-3.23	-1.83
NEP_KAWB	0	0	0

Results:

Fish biomass decreasing consistently in all scenarios but within model error (< 3% change);

Hypothesis behind the preliminary results:

Fish biomass changes co-incident with observed changes in plankton community composition, but difficult to disentangle from any error due to internal model variability;

Bio-Economic IBM DISPLACE Model

Designing an Individual Vessel based & Bio-economic Simulation Model for Integrated Stock and Fleet Management Strategy Evaluation useful for Maritime Spatial Planning

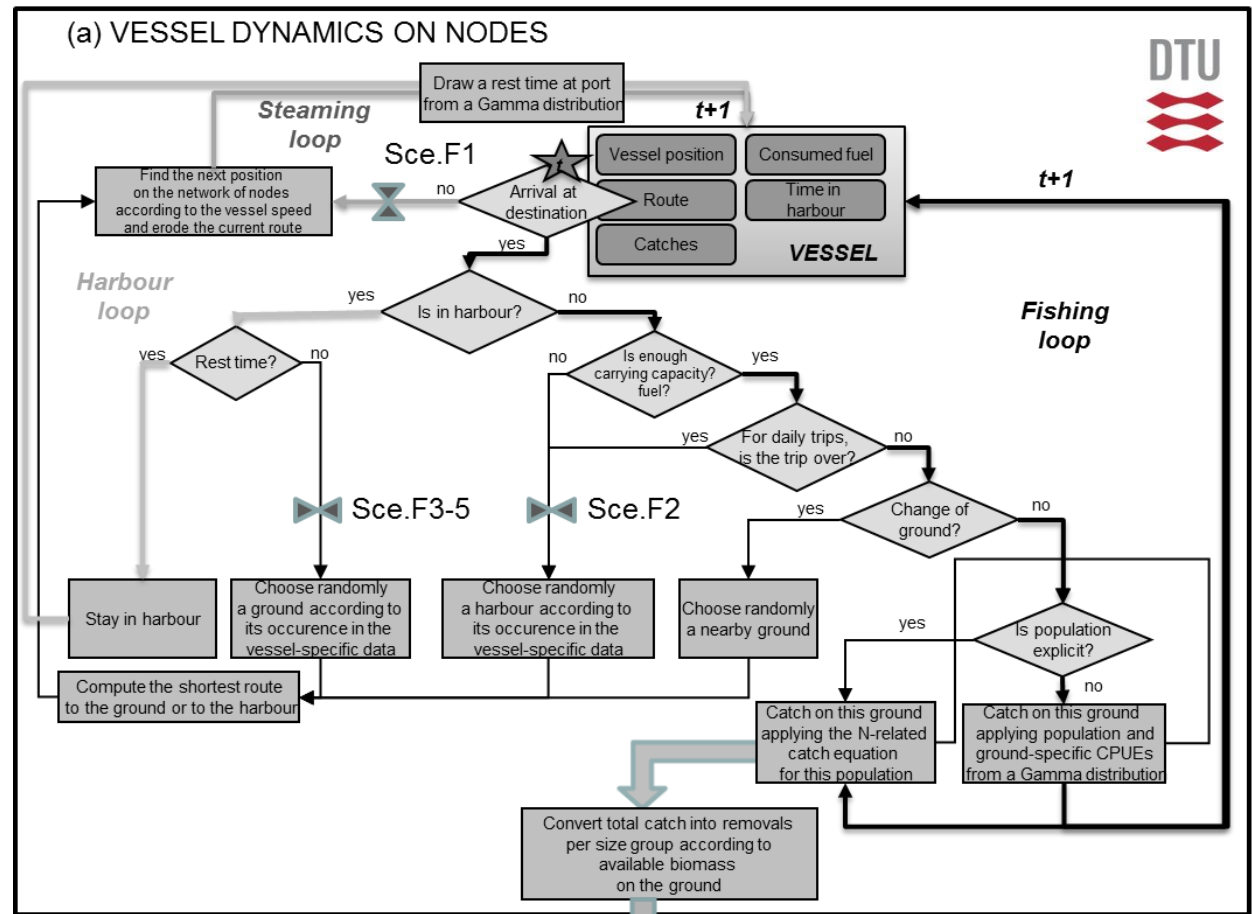

Convert total catch into removals per size group according to available biomass on the ground

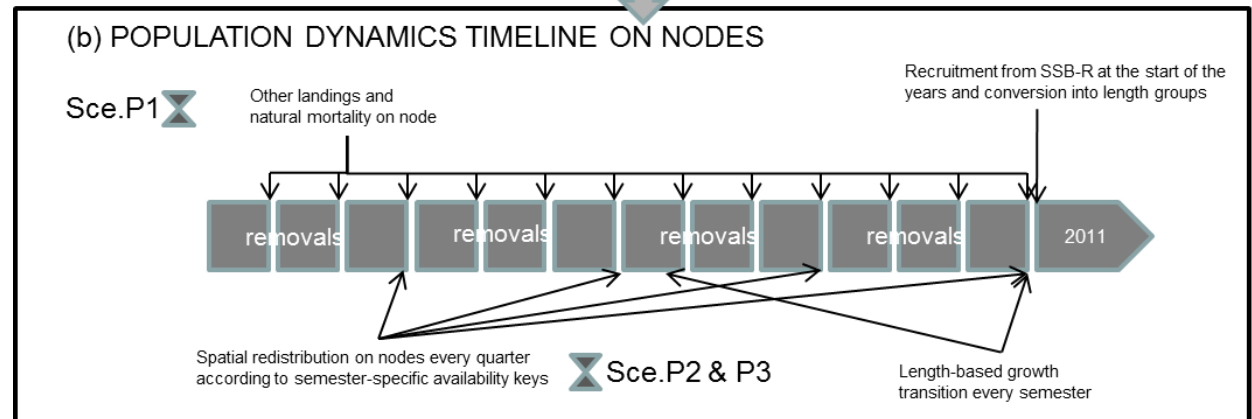
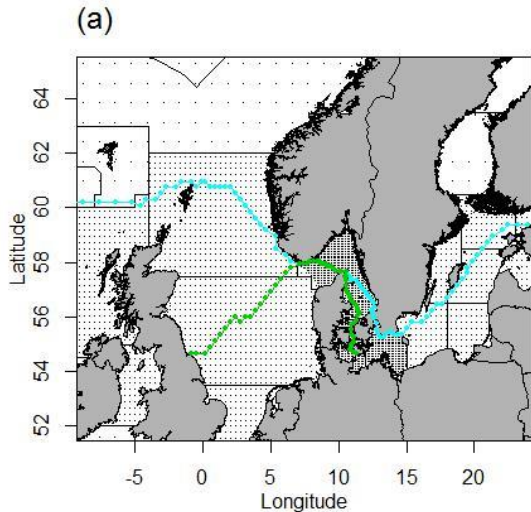

Analysing VMS tracks: Mapping Catch & Effort

Fine retrospective pattern of spatial and temporal effort and catch allocation build from satellite vessel monitoring system (VMS) tracking data on haul to haul basis within a fishing trip (trip basis) coupled to logbook and sales slips declarations

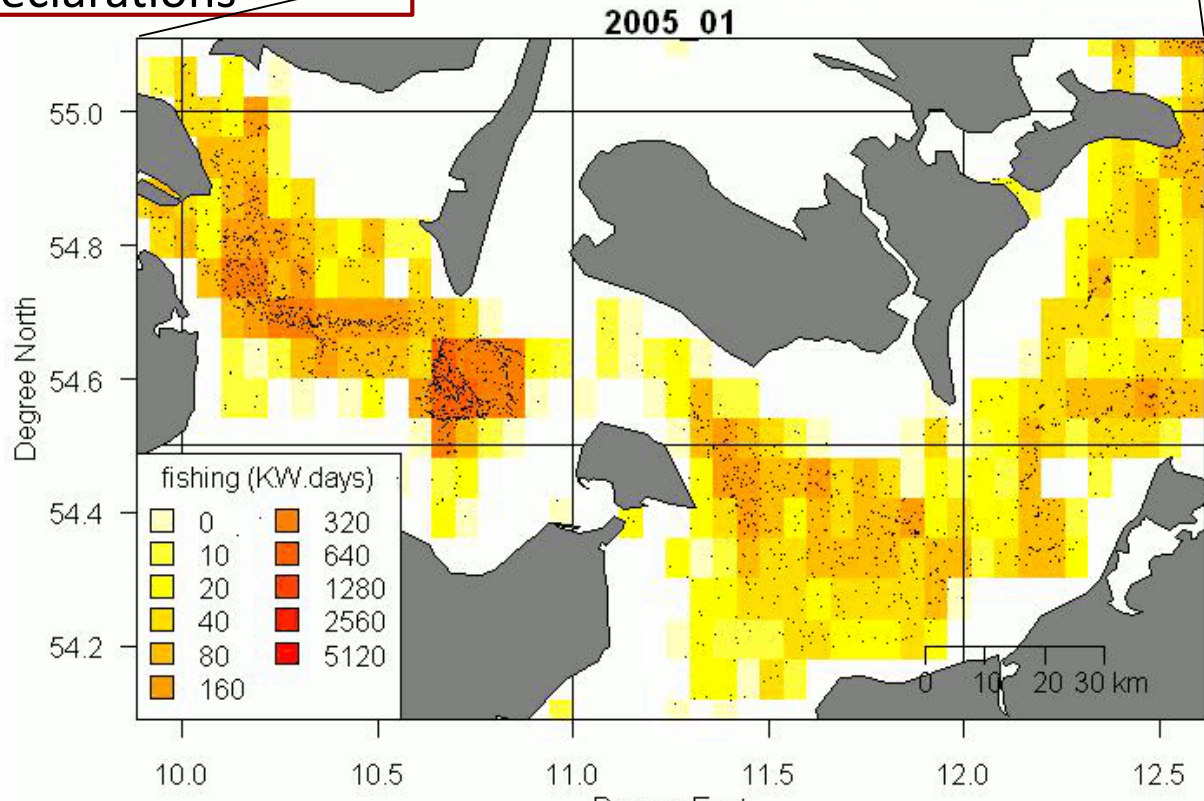
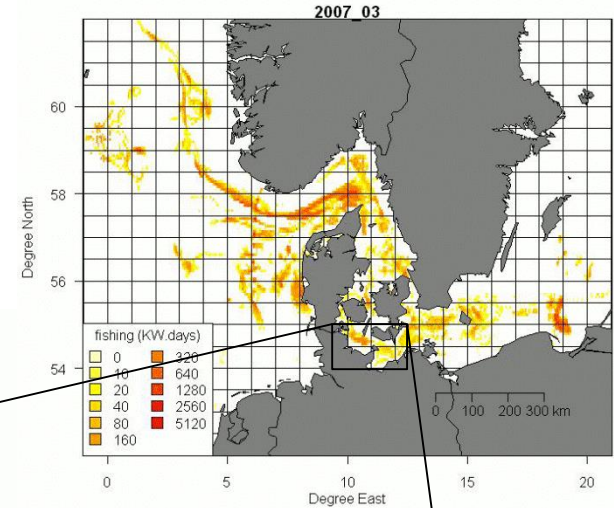

Bio-economic IBM DISPLACE Model

- An example IBM run: Effort and resulting catch / harvest scenario
- A stochastic (IBM) simulation model = forward projection with uncertainties

02-20 07:00:00

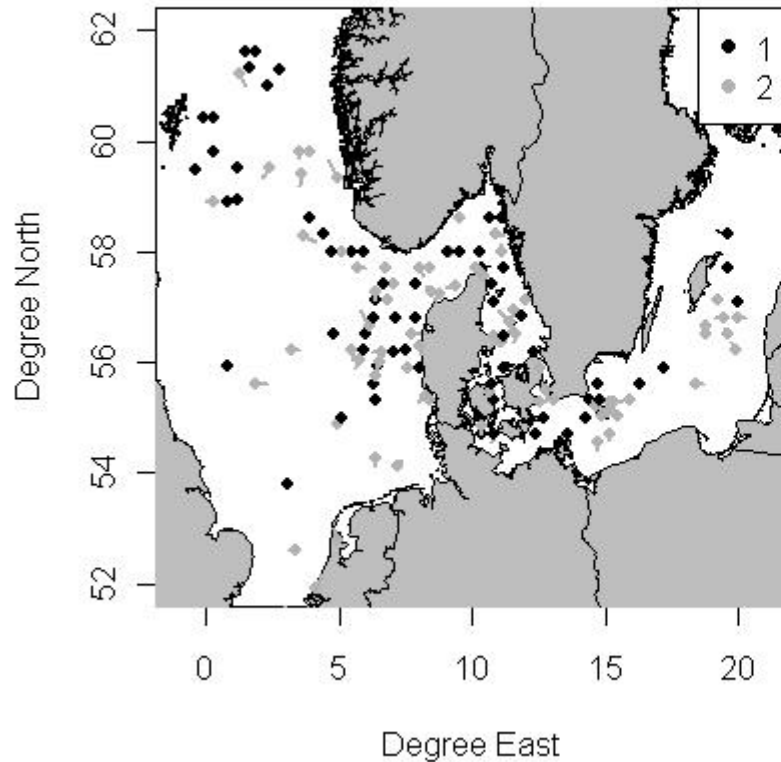

02-20 07:00:00

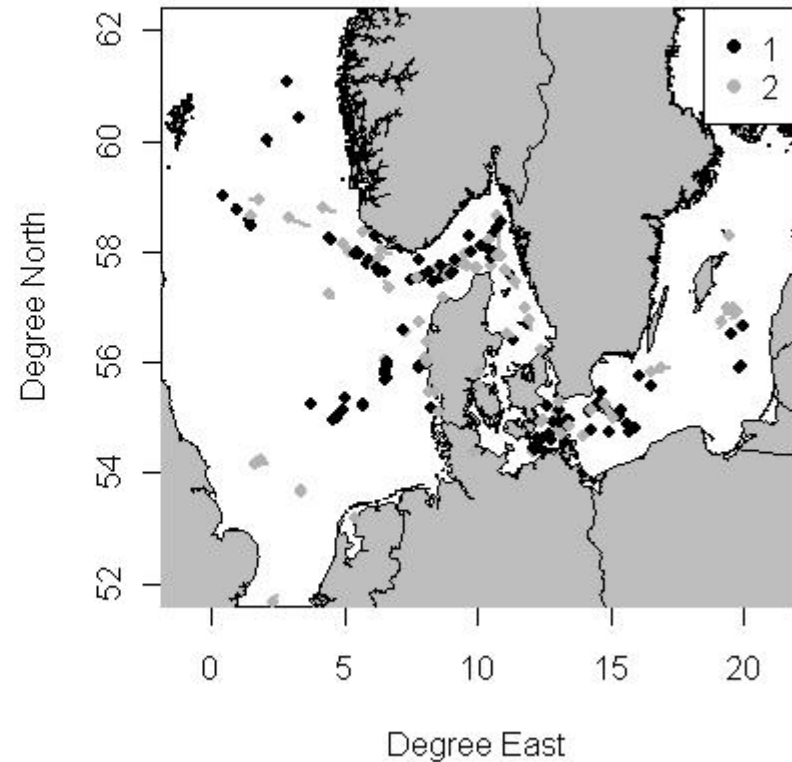

Type of Integrated Output (DISPLACE)

(a) Danish fishing effort (>15m)

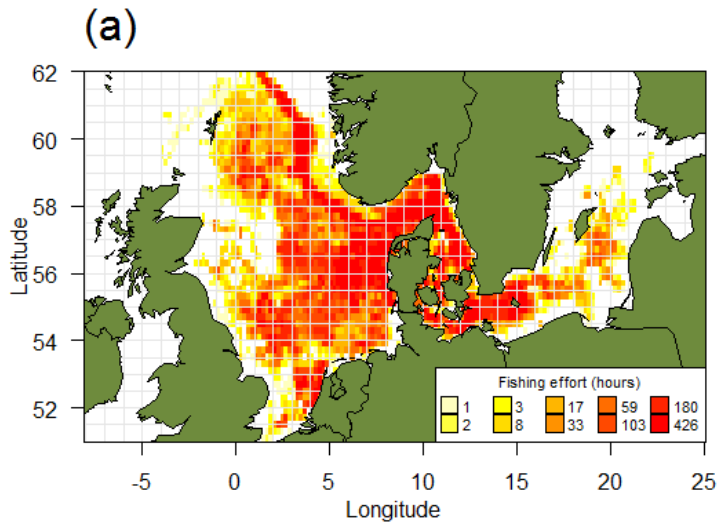

(b) origin of landings in value

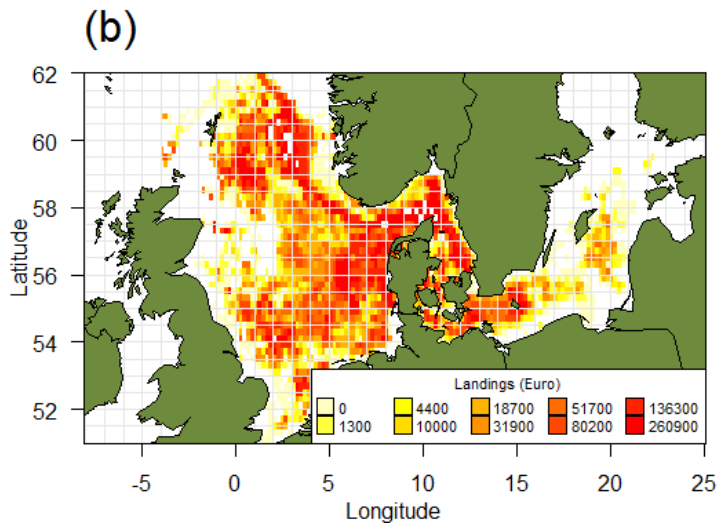

(c) % fuel consumption

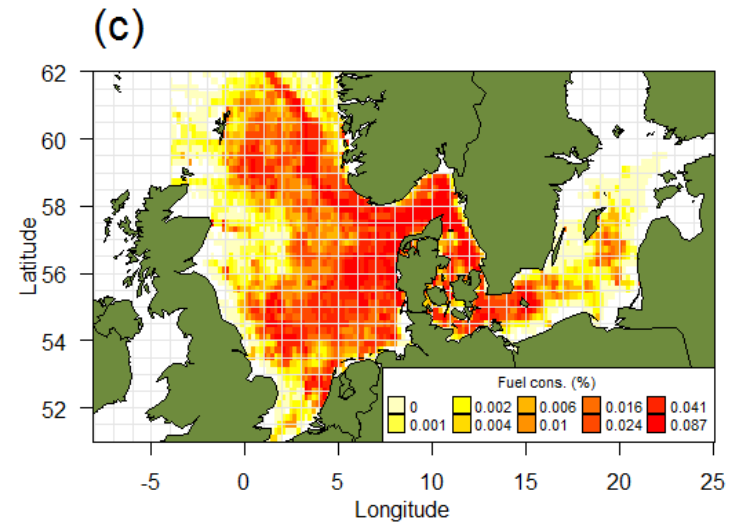

(d) fuel per hour

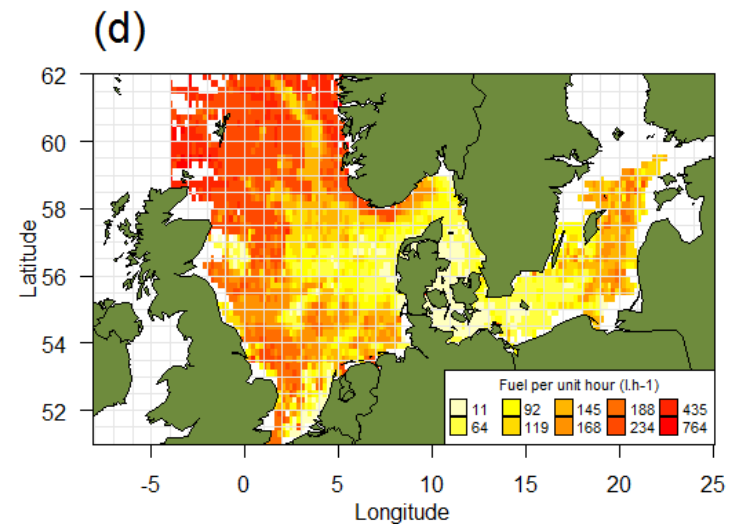

Bio-economic IBM DISPLACE Model: Example of Output (www.displace-project.org) from Run of Spatial Fisheries Scenarios - BALTIC

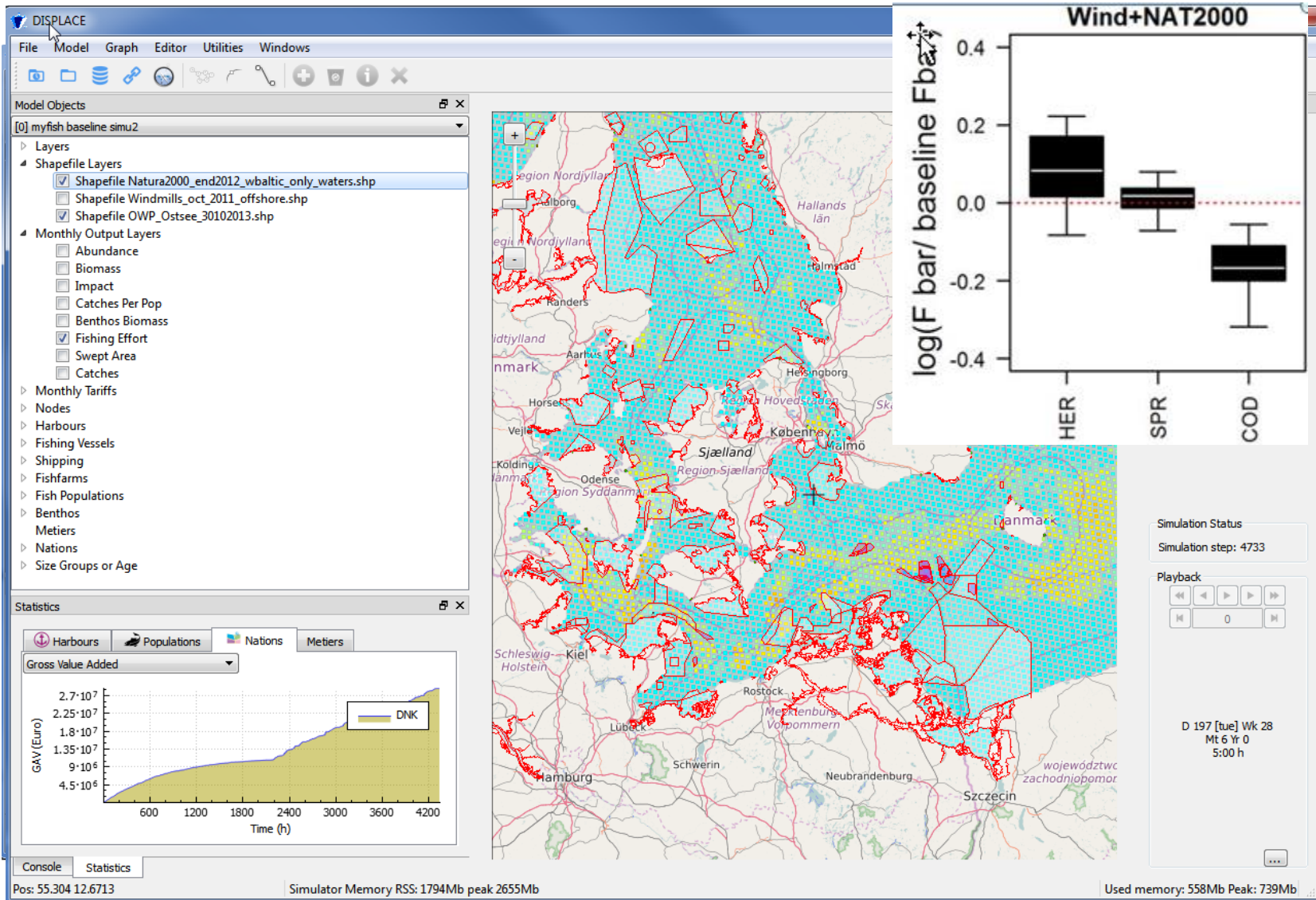

Consequences on fisheries of alternative scenarios – effort and trip patterns

Scenario	Total effort (%)	Steaming Effort (%)	Number of trips (%)	Average trip duration (%)
Wind	$-1.0 \pm 0.5^{**}$	$0.2 \pm 0.2^{**}$	$-0.5 \pm 0.2^{***}$	-0.2 ± 0.3
NAT2000	$-1.9 \pm 0.5^{***}$	$1.0 \pm 0.2^{***}$	$-4.8 \pm 0.2^{***}$	4.5 ± 0.3
Wind+NAT2000	$-2.5 \pm 0.6^{***}$	$1.1 \pm 0.2^{**}$	$-4.7 \pm 0.2^{***}$	$4.0 \pm 0.3^{***}$
LowProd	0.5 ± 0.5	0.1 ± 0.2	$-0.3 \pm 0.2^{**}$	$0.6 \pm 0.3^{**}$
NAT2000+LowProd	$-1.8 \pm 0.5^{***}$	$+1.0 \pm 0.2^{***}$	$-5.2 \pm 0.2^{**}$	$4.9 \pm 0.3^{**}$
Wind+NAT2000+LowProd	$-2.2 \pm 0.6^{***}$	$1.2 \pm 0.3^{***}$	$-5.1 \pm 0.2^{***}$	$4.7 \pm 0.4^{***}$
Wind+NAT2000+20%FuelPrice	$-1.3 \pm 0.4^{***}$	$-0.9 \pm 0.2^{***}$	$-4.7 \pm 0.2^{***}$	$3.8 \pm 0.3^{***}$

Consequences on fisheries of alternative scenarios – revenue, cost & energy efficiency

Scenario	Fuel cost (%)	CPUE cod only	CPUE cod sprat herring stocks (%)	CPUE other stocks (%)	GVA (%)	VPUF (%)
Wind	0.1 ± 0.5	-1.1 ± 0.7**	2.2 ± 3.2	-0.8 ± 1.2	1.3 ± 2.0	1.7 ± 1.8
NAT2000	-0.5 ± 0.5*	-2.4 ± 0.7***	5.9 ± 3.4**	-15.0 ± 1.2***	-2.8 ± 2.6**	-8.9 ± 1.8***
Wind+NAT2000	-0.9 ± 0.5**	-2.7 ± 0.7***	8.4 ± 3.1***	-13.7 ± 1.4***	-1.2 ± 2.5	-4.6 ± 2.0***
LowProd	-0.1 ± 0.6	-21.0 ± 0.6***	-34.6 ± 1.7***	-1.0 ± 1.5	-16.3 ± 2.3***	-7.5 ± 1.4***
NAT2000+LowProd	-0.6 ± 0.5*	-22.3 ± 0.5***	-33.4 ± 1.6***	-14.5 ± 1.3***	-19.0 ± 1.5***	-14.7 ± 1.6***
Wind+NAT2000+LowProd	-0.5 ± 0.5*	-22.6 ± 0.5***	-32.8 ± 1.6***	-13.0 ± 1.2***	-16.6 ± 2.1***	-11.0 ± 2.0***
Wind+NAT2000+20%FuelPrice	18.3 ± 0.7***	5.5 ± 0.7***	31.2 ± 3.4***	-19.2 ± 1.2***	-9.9 ± 1.8***	-8.9 ± 1.4***

Consequences on stocks of alternative scenarios – biological sustainability, SSB (and similar for F)

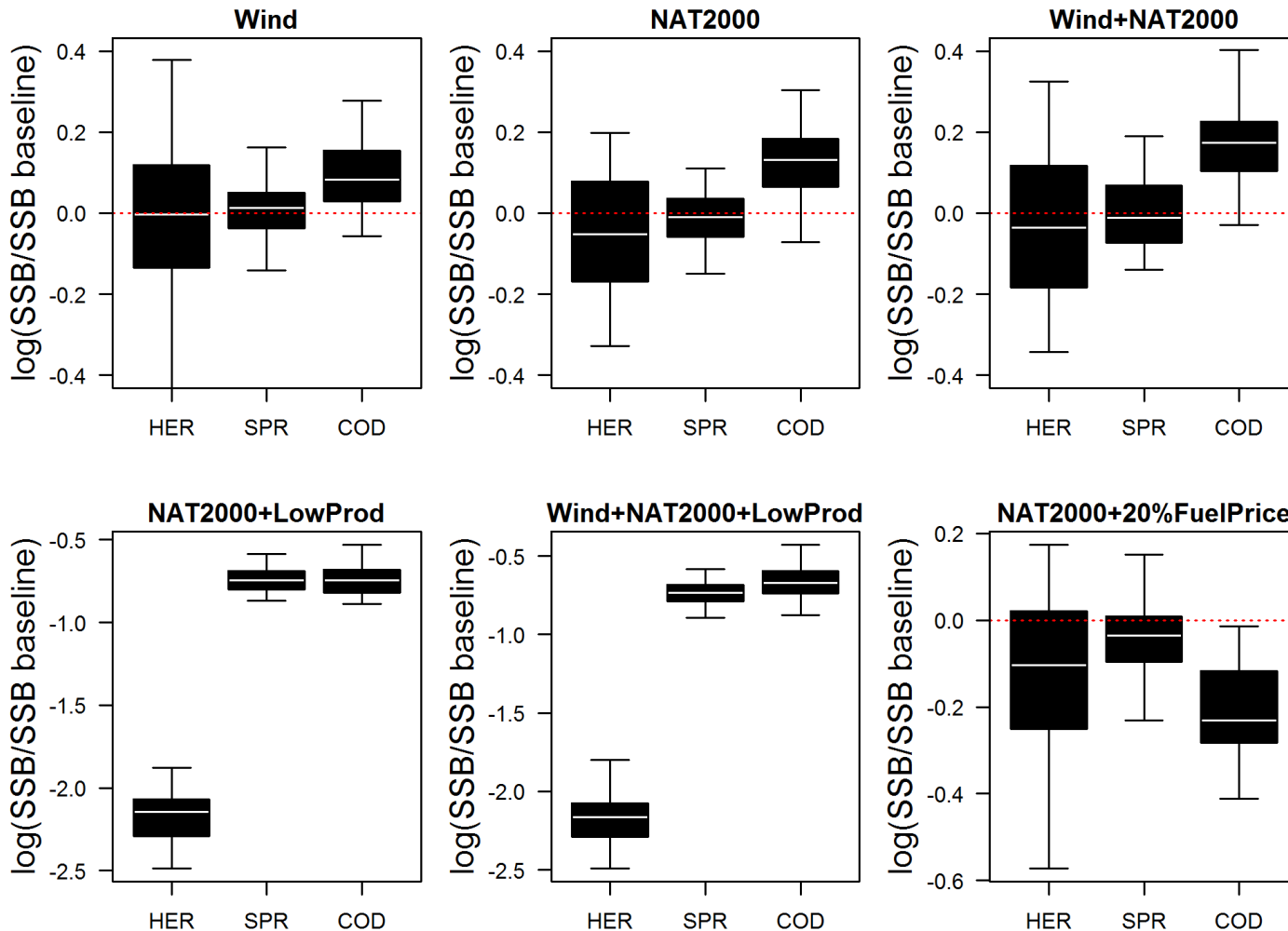

Current Baltic ATLANTIS Conceptual Framework

Illustrating currently operation and envisaged linking within the integrated modeling framework for investigating ecosystem-wide effects of human-induced pressures in Kattegat and the Western Baltic

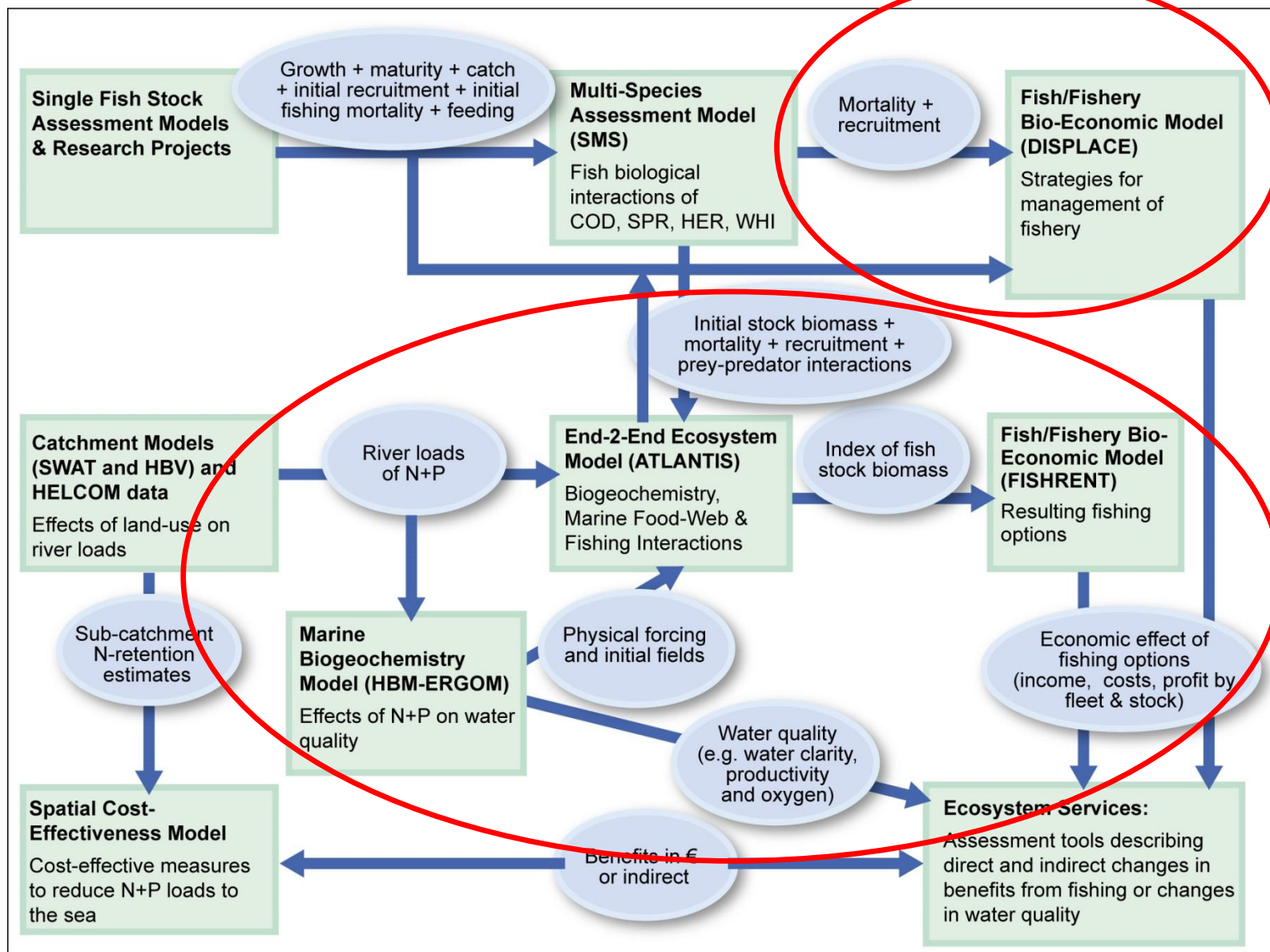

Model linking to bio-geo-chemical and physical models a cooperation with Marine Living Resources Further cooperation with Ecosystem Based Management & Population and Ecosystem Dynamics.