

Study to investigate state of knowledge of deep sea mining

Final report Annex 4 Technology Analysis

FWC MARE/2012/06 – SC E1/2013/04

Client: DG Maritime Affairs and Fisheries

Rotterdam/Brussels,

15 October 2014



Study to investigate state of knowledge of deep sea mining

Annex 4

Final Report Technology Analysis

FWC MARE/2012/06 – SC E1/2013/04

Client: DG Maritime Affairs and Fisheries

Brussels/Rotterdam, 15 October 2014

About Ecorys and Consortium Partners



Consortium leader

Economic expertise, highest quality, wide geographical coverage & broad range of services

- One of the oldest and largest economic research and consulting firms in Europe
- International recognition, highest quality & independence – including a Nobel Prize
- Clients range from local governments to the European Commission and international financing institution medium-sized companies to the largest multinationals
- 16 permanent offices in 11 countries, worldwide experience in more than 140 countries including all sea basins
- Extensive project management experience
- Experience with structural and cohesion funds, Interreg, EDF, ERDF, TRD
- Services in the areas of real estate, property and housing, transport, infrastructure, infrastructure finance and investment, logistics, ports and shipping, industry and trade, macroeconomics and public finance, environment and energy, health care, labour and education, regional and urban development, social security, tourism, agriculture and rural development
- Involving skilled staff from offices in the Netherlands, Brussels, the UK and elsewhere. Additionally, introducing training services of the Ecorys Academy



Promoting sustainable use of aquatic resources through sound integrated management policies and practices

- Designing and implementing integrated resource management systems in marine, estuarine, riverine and floodplain environments
- Consideration of the physical, biological, technical, social, economic, and institutional elements of resource utilisation
- Worldwide experience -more than 60 countries including all sea basins
- Clients include government agencies, IFIs, the European Commission in general and the Directorate-General for Maritime Affairs and Fisheries in particular, non-governmental organisations and private sector companies
- Services include: Policy and Strategic Planning, Fisheries Management, Resource Assessment, Institutional Development, Technical Training, Chain of Custody Audits, Conference and Workshop Planning, Performance Monitoring and Evaluation, Data and Information Management, Information Review, Sharing & Co-operation, Monitoring, Control and Surveillance, Preparation work for Fisheries Certification



Communicate environmental information to policy-makers and facilitate environmental decision-making for change

- Official United Nations Environment Programme (UNEP) collaborating centre, supporting informed decision making and awareness-raising through:
- Environmental information management and assessment
- Capacity building services
- Outreach and communication tools, methodologies and products
- A dynamic portfolio of projects
- Initiatives in the Polar Regions and Outermost Regions, and sustainable development of the oceans and coasts elsewhere in the world.

Consortium Lead Partner
ECORYS Nederland BV
P.O. Box 4175
3006 AD Rotterdam
The Netherlands

T +31 (0)10 453 88 00
F +31 (0)10 453 07 68
E fwcbluegrowth@ecorys.com
Registration no. 24316726
www.ecorys.com

Table of contents

Summary	7
1 Exploration techniques	9
1.1 Introduction to exploration	9
1.2 Integral environmental impact	10
2 Technology assessment: Locating	12
2.1 Research vessels	12
2.2 Echo sounding (sonar) bathymetry	14
2.3 Electromagnetics	17
2.4 Water-chemistry/column testing	19
2.5 Autonomous underwater vehicle (AUV)	20
2.6 Remotely operated vehicle (ROVs)	22
3 Technology assessment: Sampling	24
3.1 Free-fall devices	24
3.2 Grab samplers	25
3.3 Box corers	26
3.4 Gravity corer	27
3.5 Piston corers	28
3.6 Vibrocoreing	29
3.7 Technology assessment: Drilling	30
3.8 Drill rigs/ROV based drills	31
3.9 Ship based drills	32
4 Resource Assessment, Reserve Evaluation and Mine Planning	34
4.1 Introduction into the project planning phase	34
4.2 Technology assessment: Resource Modelling	34
4.3 3D Geometallurgical Modelling of seafloor massive sulphides	35
4.4 2D Multivariate Modelling	36
4.5 Procedural assessment: Reserve Estimation and Mine Planning	36
4.6 Long-Term Deep-Sea Mine Planning	36
4.7 Medium- and Short-Term Deep-Sea Mine Planning	37
4.8 Resource/Reserve Reporting Codes	39
5 Extraction, lifting and surface operations	40
5.1 Introduction into extraction, lifting and surface operations	40
5.2 Technology assessment: Excavation	40
5.3 Polymetallic Sulphides (seafloor massive sulphides)	41
5.4 ROV Clamshell grab (+ seabed rock crusher or skip hoist system)- seafloor massive sulphides	45
5.5 Polymetallic Nodules	46
5.6 (Cobalt-rich) Ferromanganese Crusts	50
5.7 Technology assessment: Pre-processing at the seafloor	51
5.8 Identification	52
5.9 Sensors	52
5.10 Sampling	52
5.11 Ore/loose sediment separation	53

5.12	Size reduction – crushing at the sea floor	54
5.13	Concentration at seafloor	54
5.14	Technology assessment: Stock & Dispatch systems	55
5.15	Technology assessment: Vertical transportation	56
5.16	Air Lift System	57
5.17	Technology Assessment: Surface Operations	62
5.18	Technology assessment: Support vessel	64
6	Offshore and onshore logistics	67
6.1	Introduction into transportation, handling and storage	67
6.2	Technology assessment Transshipment from platform to ore carrier	67
6.3	Technology assessment: Sea-transport	67
6.4	Technology assessment: Terminal-operations	67
6.5	Technology assessment: Storage	68
6.6	Technology assessment: Land transport	68
7	Processing techniques	69
7.1	Introduction into Processing	69
7.2	Technology assessment: Comminution	70
7.3	Technology Assessment: Classification	76
7.4	Technology assessment: Mineral Separation	77
7.5	Technology assessment: Tailings Handling	82
7.6	Technology assessment: Metal Extraction	83
8	Ongoing EU research efforts	89

List of abbreviations

AUV	Autonomous underwater vehicles
Ag	Silver
AG	Autogenous
As	Arsenic
Au	Gold
Bi	Bismuth
CSEM	controlled-source electromagnetic
CTD	Conductivity, Temperature, and Depth
Cu	Copper
DP	dynamic positioning
Fe	Iron
Ir	Iridium
Mn	Manganese
Mo	Molybdenum
MT	Magnetotelluric
Nb	Niobium
Os	Osmium
Pb	Lead
Pd	Palladium
PDTS	Placer Dome Technical Services
PGE	Platinum group elements
PNG	Papua New Guinea
PSP	Production Support Platforms
PSV	Production Support Vessel
Pt	Platinum group elements
Rh	Rhodium
ROV	Remotely operated vehicles
Ru	Ruthenium
SAG	Semi-autogenous
Sb	Antimony
SPS	Seafloor Production System
Te	Tellurium
Ti	Thorium
TML	Transportable moisture limit
TRL	Technological Readiness Level
W	Tungsten
Zn	Zinc
Zr	Zirconium

Summary

Whether deep-sea mining will become viable in the near future depends to a large extent on the ability of industry and technology developers to provide systems capable of efficient operation in real life environments. Until now there is no commercial seabed mining of any of the three deposits taking place which means there is no proven equipment directly available. The majority of current activities are associated to exploration rather than exploitation.

In order to assess the technical state of play and identify the main barriers/bottlenecks to be tackled, a deep-sea mining value chain has been composed and its components assessed in terms of their technology readiness level (TRL). Furthermore, for each component the role that EU industries take is estimated.

Typically, the process of deep-sea mining, following exploration, will consist of a seabed remotely operated vehicle to collect (nodules) or excavate the deposit (sulphides, crusts), which is connected to a vertical transport system to lift the material to the sea surface, where it is collected in a ship or platform, dewatered and then transferred in a carrier and transported to shore for further processing.

A schematic presentation of the value chain for deep-sea mining is given in the figure below.

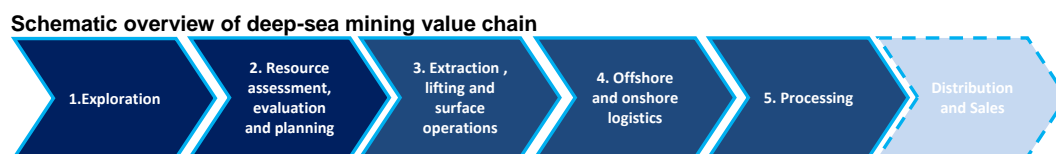

Typically, exploration involves locating, sampling and drilling, using technologies such as echo-sounders, sonars, camera's and sampling techniques. The resource assessment phase concerns the analysis of exploration data as regards the feasibility of a possible mining project.

Extraction, lifting and surface operations, the core part of the exploitation phase, encompass the excavation of the sea bed minerals, their transportation to the surface and eventual processing and handling operations taking place offshore. For the sea bed excavation, cutters (for sulphides and crusts) or collectors (for nodules) and rising systems are being developed. For the vertical transport, various concepts of lifting systems are being studied.

Logistics involves technologies similar to those found in 'traditional' land-originating minerals. For processing this is also the case although mineral composition differences call for development of advanced separation techniques.

For polymetallic crusts, the requirements of the seabed ROV differ from those related to sulphides and crusts due to the different nature of the deposit layers (hardness, composition, structure). Apart from these differences also the surface differences between sites define the requirements of the seabed equipment (e.g. steepness of slopes, curves to be made) as well as the water depth (pressure and temperature) in which to operate.

Typically, TRL levels are lower (range 1-4) for technologies required on the sea bed and for vertical transport, whereas technologies required at sea level (ship/platform and associated equipment) and

onshore are more mature as they have similarity to applications in other sectors already existing. The role of EU industries in deep-sea mining has mainly focused on developing technologies – for the sub-sea part – and providing services (e.g. for construction of project sites and for exploration work). Typically the high technology capabilities of EU companies give them a competitive advantage over suppliers from elsewhere. When looking more downstream to surface and shore operations, this is less the case and competition from across the world can be expected.

1 Exploration techniques

1.1 Introduction to exploration

In order to assess the potential of mining resources on the seabed, one has to identify, test and delineate the deep sea mineral resources. To achieve this, the geographical and geological conditions need to be investigated. Different types of equipment and techniques have been developed for this investigation, which will be reviewed in the subsequent paragraphs.

Several activities and stages can be pursued in the exploration phase, also depending on the type of resources to be mined. However, these phases or exploration steps often involve the same type of technologies for different purposes. By grouping the technologies to their technical purpose (not per se exploration steps), we identify the following main activities within the exploration phase for deep sea mining.

Figure A.4.1.1 Activities within the Exploration phase

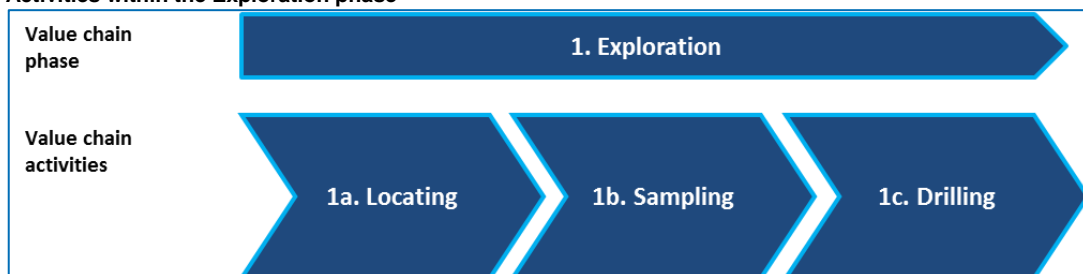

For each of these activities, advanced technologies are used such as echo sounders, autonomous underwater vehicles (AUVs), remotely operated vehicles (ROVs), water sampling equipment, video systems, and more (see Figure A.4.1.2).

Box: Exploration strategy for Solwara 1

As an example, Nautilus Minerals Inc. aims to follow the next steps within their exploration strategy for the Solwara 1 project in the territorial waters of Papua-New Guinea:

1. Project Generation – Identify and secure title over the most prospective areas for Seafloor Massive Sulphides mineralisation;
2. Target Generation – Identify and rank sufficient high quality targets to ensure new seafloor massive sulphides systems can be discovered at a sufficient rate to provide continual growth options to Nautilus;
3. Target Testing – Discover new seafloor massive sulphides systems at a sufficient rate to provide continual growth options to Nautilus;
4. Prospect Delineation – Focus resource evaluation work with mapping, sampling and geophysics;
5. Resource Evaluation – Drilling, resource estimation, metallurgical test work and environmental impact statement.

Over these steps, the locating, sampling and drilling exercises are performed at multiple stages but with different intensities and at different depths and levels of accuracy.

Figure A.4.1.2 Examples of exploration techniques and tools

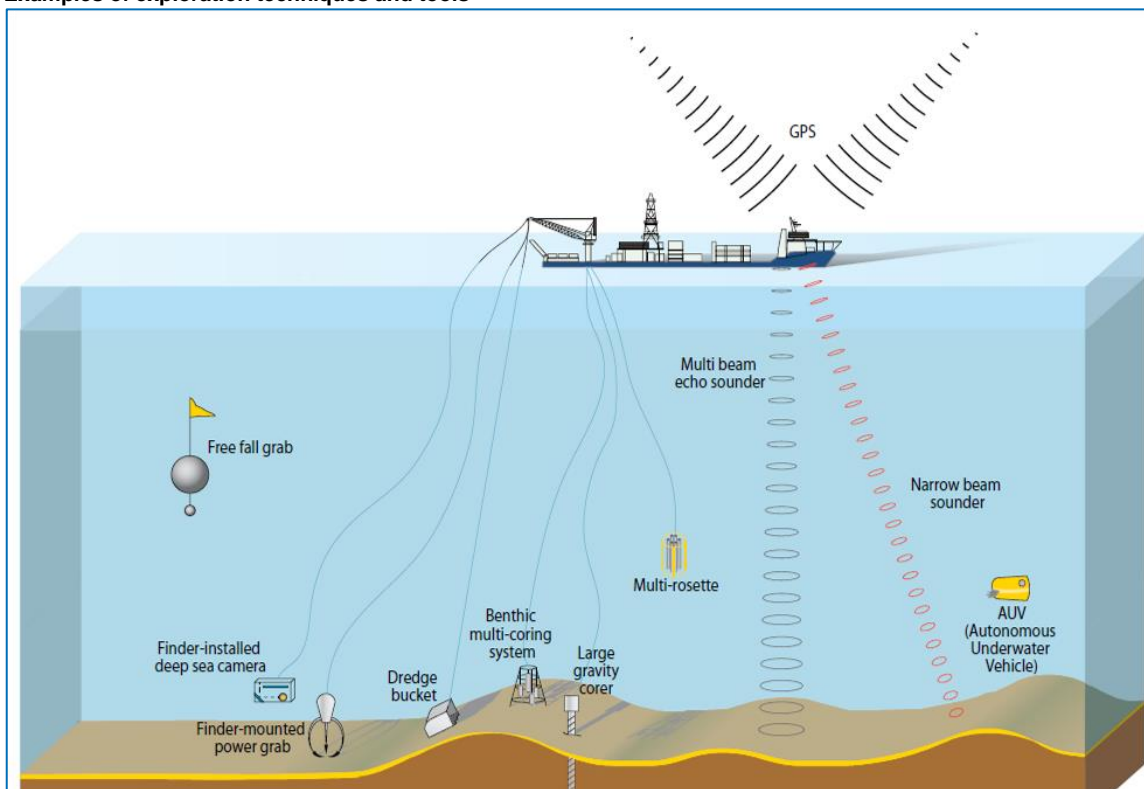

Source: SPC (2013). Deep Sea Minerals: Sea-Floor Massive Sulphides, a physical, biological, environmental, and technical review. Baker, E., and Beaudoin, Y. (Eds.) Vol. 1A, Secretariat of the Pacific Community.

1.2 Integral environmental impact

Deep-sea mining is a pioneering activity which interacts with flora and fauna on the seafloor and water column. As ‘unknown’ practice, the environmental effects of deep-sea mining are monitored closely. The question therefore may rise; to what extent are the different techniques available and under development for deep-sea mining activities impacting the environment? Is it true that some techniques disturb less?

First of all, it is important to note that there are differences in impacts depending on the deposit type as well as the geomorphological setting, physical conditions, the scale of operations, and therefore also depending on the technology used for extraction. The technology being developed for deep-sea mining depends on the above mentioned characteristics of the setting, deposit and location. Tailor-made solutions are developed depending on these different mining characteristics. It is therefore impossible to ‘pick’ or choose a certain technology. Technologies are yet still under development, as the TRL levels have shown in this report.

Pioneering in this field involve major investments to make, not without financial risk. Given the attention the deep-sea mining industry receives from stakeholders, none of the companies would be willing to add risks to their investment by developing environmentally harming techniques. Before licenses are issued, environmental impact assessments need to be approved, including the techniques and mitigating actions concerning the environment.

Therefore, it can be expected that the technologies being developed at the moment are technologies that mitigate environmental impact as much as possible. Acting not environmentally

friendly is per se non-economically attractive, as the risk is too high that the projects will be cancelled or licenses will be retracted.

Though, there are certain stages in the deep-sea mining value chain which are expected to impact the environment more than others. This holds especially for the extraction phase, as interference takes place with the seafloor habitat. The extraction processes that are expected to have environmental impacts are the following:

- Disaggregation
- Lifting
- Dewatering.

The companies spoken to during the course of this study have all shown their efforts and concerns regarding the environmental impact of deep-sea mining. The above activities are developed with great concern.

More about deep-sea mining and the environment can be found under Chapter 6, environmental implications.

2 Technology assessment: Locating

In order to identify the locations of mineral deposits at the seafloor and to delineate these areas, several geophysical and geochemical techniques are used to map the seafloor. These methods are quite similar to those used for marine scientific purposes and the basic techniques are for most type of deposits already developed and currently in use for exploring the seafloor for both scientific and commercial purposes.

The techniques available and used for locating and mapping the seafloor are the following:

- Research vessels;
- Echo sounder bathymetry (single beam, multibeam, sidescan);
- Electromagnetics;
- Water-chemistry testing;
- Remotely operating vehicle (ROV);
- Autonomous Underwater Vehicle (AUV).

2.1 Research vessels

Deep-sea exploration is facilitated through the use of modern research vessels. These vessels facilitate and host the multi-purposes research activities for exploring the seafloor. Almost all techniques used for locating, sampling and drilling require some sort of support from the research vessel.

A typical research vessel is capable of operating for a maximum of 200 days per year due to passage time, maintenance and port time. Often, these vessels are chartered out for multiple purposes, not only deep-sea research. If 30% of that time is allocated to deep-sea research then 60 scientific days per ship represents the limit of current capability, per year. Through the use of multiple autonomous vehicles and techniques at once, research time is maximized as much as possible¹. This poses substantial equipment control requirements for these mother ships.

Literature² provides the following common requirements for modern deep-sea research vessels:

- wide operation range throughout all climatic zones;
- protected deck areas with sufficient space;
- a high number of cabins for technical and scientific crew;
- a wide range of winch- and crane-based operability;
- multipurpose laboratories;
- excellent seafloor mapping and environmental sensing capabilities;
- advanced data distribution, storage and communication systems;
- dynamic positioning and navigation systems.

As an example of a dedicated research vessel for exploring polymetallic sulphides, the Dorado Discovery is shown here. Being chartered by Odyssey Marine Exploration (U.S.), this 100mx18m vessel is exploring the seabed for seafloor massive sulphides deposits. Odyssey provides these year-round exploration services for Neptune Minerals (US).

¹ EC(2007) The Deep-Sea Frontier: Science challenges for a sustainable future.

² ibid

Figure A.4.2.1 The Research Vessel Dorado Discovery



Source: courtesy of Odyssey Marine Exploration.

The table below provides some insights in the features and specifications of such research vessel.

Table A.4.2.1 Features of the Dorado Discovery

Features	
Principal features	
Gross Tonnage	5099 GT
Built	Gdansk, 1997
Length	100m
Breadth	18m
Depth	7m
Accommodations	
Cabins	42 single + 6 double
TV Lounge	2
Labs	Survey, Geological, Exploration, Technical and Scientific
Other	
	Refrigerated storage of samples and cores
	Water chemistry lab
	Briefing room
	Gym
	Seafloor Drill
	Launch and Recovery System

Source: Odyssey Marine Exploration.

Availability/companies

Currently only a few European ships, most of them owned/operated by research institutions, meet these requirements and they need strategic replacement and improvement. As the figure below shows the Member States of UK, France and Germany have the most significant size fleet. Since the research fleets are operated and planned on a national level, an effort is needed on a European level to improve access, management and strategic planning of ship replacement and innovation.

Europe's research fleet is its main asset for realising the scientific goals and tasks associated with understanding deep-ocean processes. In Europe, around 260 research vessels are currently operated, of which 90 have the size for ocean and global operations. The figure below presents the vessels per country.

Figure A.4.2.2 Number of research vessel per country and size

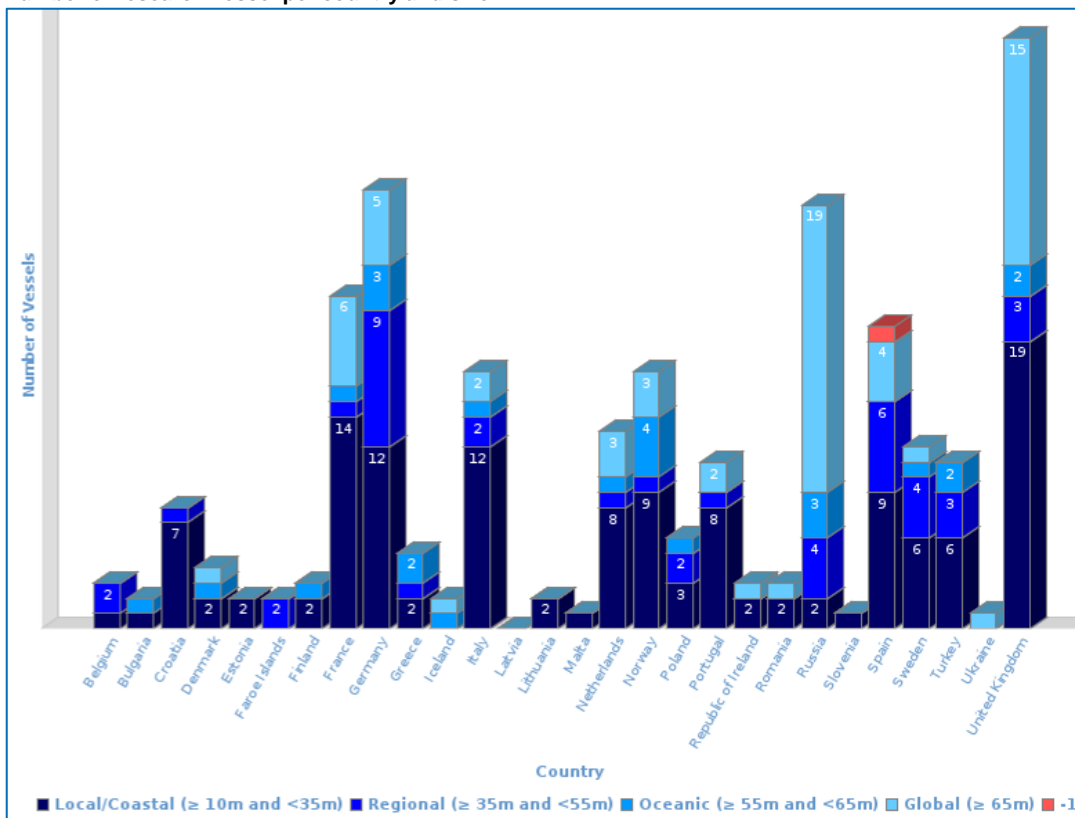

Source: Eurocean; European research vessels infobase.

Technology readiness Level

Technological Readiness Level

TRL - TRL - TRL - TRL - TRL - TRL - TRL - TRL - TRL -

1 2 3 4 5 6 7 8 9

Technical readiness level: 9, actual system proven in operational environment.

Research vessels are currently in use for exploring the deeper seabed. The research technologies used on/from these vessels may however be in other stages of development, see subsequent sections.

2.2 Echo sounding (sonar) bathymetry

Echo sounding technologies are being used since the 1930s to investigate the topography of the ocean bottom. Echo sounders emit sound waves in a broad-angle cone and from the time interval separating the emission of a sound pulse and the reception of its echo from the seabed, the depth can be calculated. Acoustic methods are ubiquitous in marine applications, since electromagnetic radiation is rapidly attenuated in the ocean so radio waves and visible light for example, which are used extensively in air, are of little use.

In particular, three types of equipment can be distinguished:

- Single beam echo sounder;
- Multibeam echo sounder;
- Sidescan sonar.

The single beam echo sounder sends a single acoustic signal vertically below the vessel. The signal returns local depth information. The echo is picked up by the transducer located on the hull of the vessel. The multibeam echo sounder however transmits multiple echo sounds with a different gradient to the seafloor and therefore collects info on a wider scale at either side of the vessel's track. For mapping exercises, the multibeam has therefore superseded the single beam applications. The ship-based multibeam systems are used to map shallow and deep water. However, when used on an Autonomous Underwater Vehicle (AUV), more detailed mapping can be acquired. These multibeam echo sounders make it possible to produce a map of the ocean floor on board the ship within a minute, making it possible to 'read' the topography of a strip of ocean bottom in real time. An example of the different images of the seafloor from ship-based and AUV based sonars is shown below.

Figure A.4.2.3 Bathymetry maps of a mud volcano at 1000m depth with left: ship-based multibeam and right: AUV application.

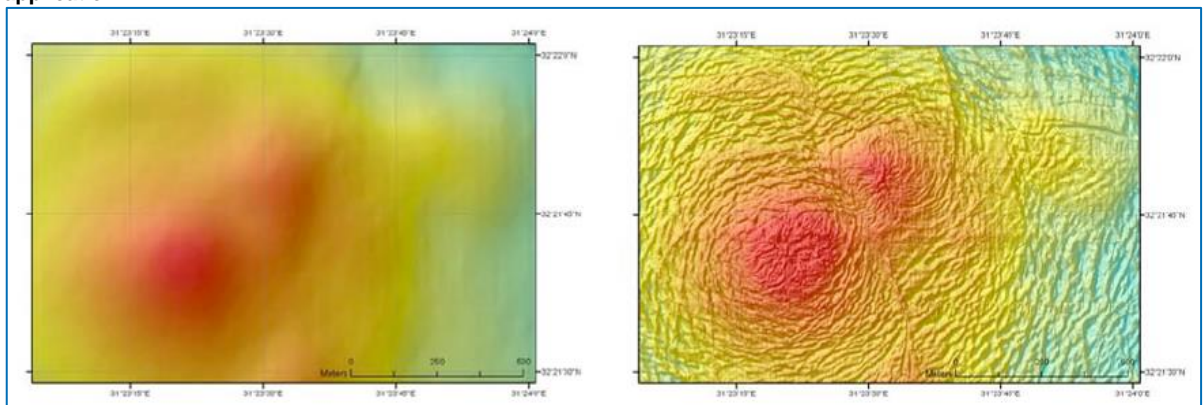

Source: Expedition METEOR M70/2 BIONIL, ESF EUROCORES EuroMargin project MEDIFLUX, from EC(2007) The Deep-Sea Frontier: Science challenges for a sustainable future.

The third application is the sidescan sonar. These sonar systems are best used on a 'towed' fish which is connected with the vessel. By having the sonar close to the seafloor, the angle of which the sonar hits the floor is small. This allows to identify shapes on the seabed. In addition, some information on the morphology and substrate can be gathered as well by measuring the reflectivity of the signal.

Figure A.4.2.4 Typical side-scan sonar fish



Source: Acoustic Techniques for Seabed Classification (2005).

In order to compare the application of the three devices, the following picture can be used. It shows the mapping coverage of each of the systems.

Figure A.4.2.5 Single beam, multibeam and sidescan coverage

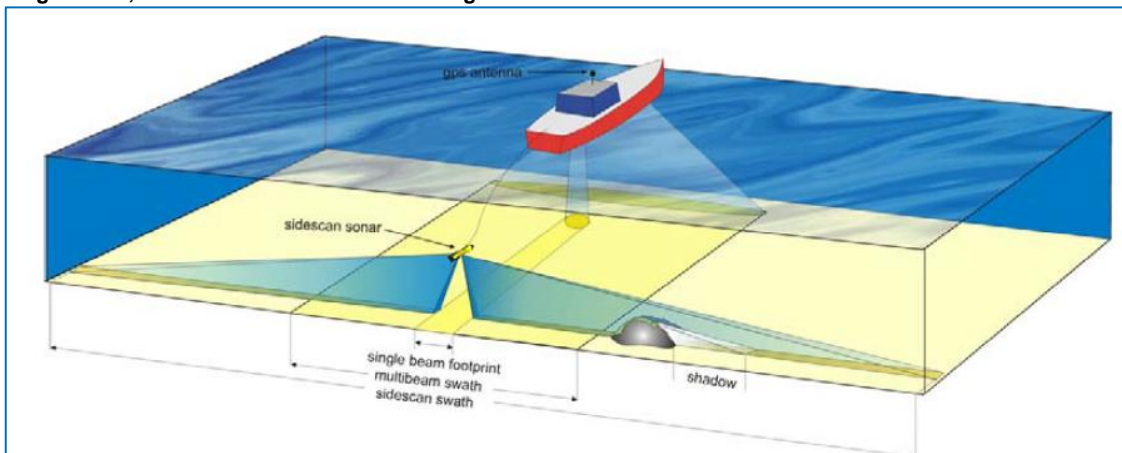

Source: Acoustic Techniques for Seabed Classification (2005).

These systems help to explore and detect the presence of deposits at the seafloor. But besides that, continuous optical imagery together with precise navigation and positioning helps identifying and characterise habitat diversity and distribution as well as seafloor activity and composition. These observations are therefore crucial in order to understand the ecosystem diversity which should reduce the impact on deep-sea ecosystems.

The three techniques can all be used for the exploration of nodules, crusts and seafloor massive sulphides and may work in unison. For polymetallic nodules, the first phase is involves large scale surveys where the multibeam systems can provide the bathymetric maps. On this basis, areas not suited for mining can be eliminated. The second stage involves more detailed imagery, often established through sidescan sonars.

For seafloor massive sulphides and ferromanganese crusts, the combination of ship-mounted multibeam sonars and sidescans is also sufficient for the first stage of detecting seafloor massive sulphides sites. However, these structures are more difficult to locate and therefore AUV's are often used for providing high resolution images. For sulphides, there is distinction between active and inactive sites. So far, most exploration efforts focused on the active sites. Research is necessary to develop methods for better detection of inactive sites as well.

Company – overview

- Edgetech (US);
- Kongsberg (NO);
- L-3 Klein Associates (US);
- Teledyne Reson (US);
- C-MAX(UK);
- Tritech (UK).

Technology readiness level

The echo sounding systems are proven techniques already applied in the deep-sea environment.

Technological Readiness Level

TRL - 1	TRL - 2	TRL - 3	TRL - 4	TRL - 5	TRL - 6	TRL - 7	TRL - 8	TRL - 9
---------	---------	---------	---------	---------	---------	---------	---------	---------

Technical readiness level: 9, actual system proven in operational environment.

2.3 Electromagnetics

Offshore electromagnetic exploration technologies include: controlled-source electromagnetic (CSEM) surveying and magnetotelluric (MT) surveying.

In CSEM surveying, a powerful horizontal electromagnetic transmitter is connected to a ship with a long cable and towed about 30m above the seafloor. The transmitter source transmits a carefully designed, low-frequency electromagnetic signal into the subsurface. An array of electromagnetic seabed receivers measure the energy that has propagated through the sea and the subsurface. Data processing, post-modelling and inversion are performed to produce 3D resistivity volumes. These datasets are integrated with other subsurface information such as to enable to make important drilling decisions with greater confidence.

Within the Solwara exploration phase for seafloor massive sulphides at PNG by Nautilus Minerals, the following type of records were made by using electromagnetics systems on the vessel Fugro Solstice.

Figure A.4.2.6 Example of electromagnetic exploration survey results for Solwara 1

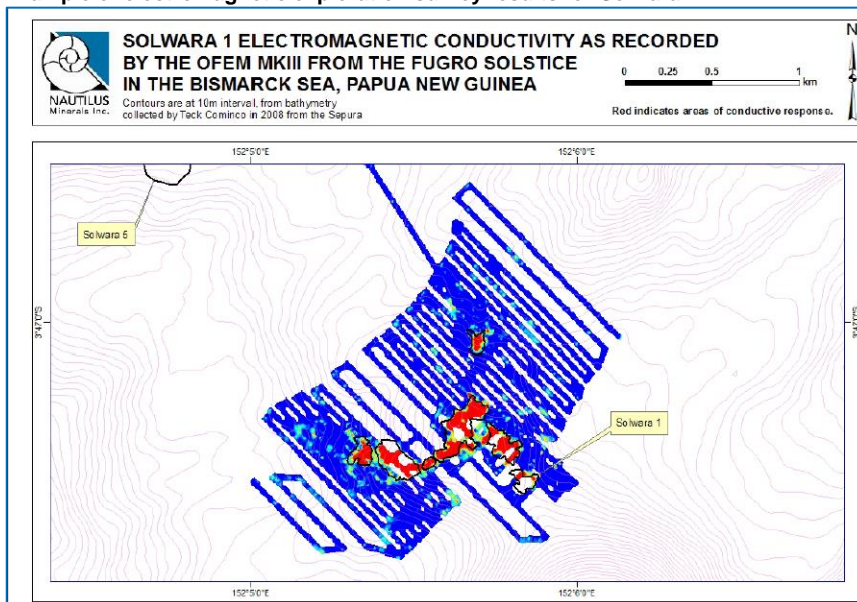

Source: SRK Consulting (2010).

More recently, research efforts have been conducted to apply CSEM surveying by applying the method on AUVs for seafloor massive sulphides exploration.

Figure A.4.2.7 CSEM applied on AUV for seafloor massive sulphides exploration, graphics.

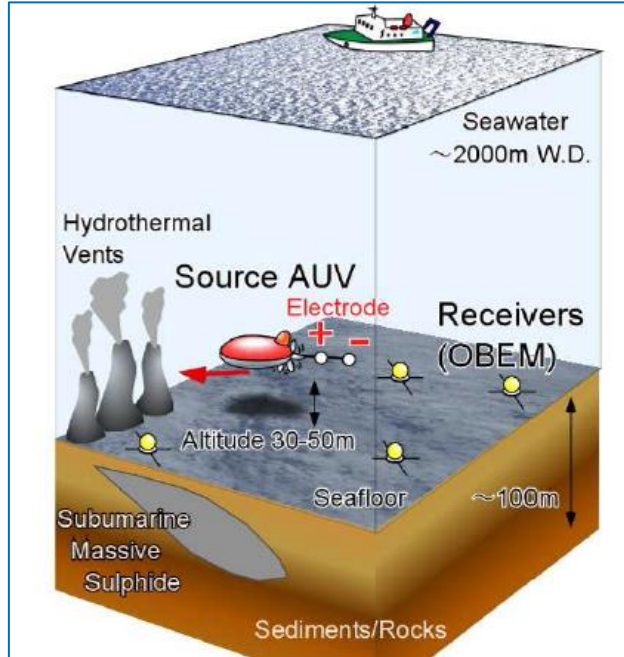

Source: Goto et al. (2012) Electromagnetic survey around the seafloor massive sulphide using autonomous underwater vehicle.

In a similar way to CSEM surveying, the MT technique is sensitive to resistive bodies in the subsurface. Marine MT surveys map subsurface resistivity variations by measuring naturally occurring electric and magnetic fields on the seabed. The sensitivity of receivers enables to acquire high-quality MT data inherently as part of a CSEM survey when the controlled source is inactive. The naturally occurring electric and magnetic fields are generated by the interactions of solar wind with the Earth's magnetic field, which when strong, are known as geomagnetic storms. The source fields are very low frequency, which offers excellent depth penetration.

The low-frequency, deep-sensing nature of MT surveying makes the technique excellent for mapping and interpreting regional geology. MT technology does not have the same sensitivity towards thin horizontal resistors as the CSEM technique; rather it can penetrate the thicker resistive layers that might otherwise be challenging for CSEM and seismic techniques³.

Companies – overview

EMGS(NO);

WesternGeco (UK);

PetroMarker(NO).

Technology readiness level

The technology has been proven as ship-mounted operation (TRL-9), for electromagnetics applied at AUVs, there has so far only been tests (TRL-7).

Technological Readiness Level

TRL - 1 TRL - 2 TRL - 3 TRL - 4 TRL - 5 TRL - 6 TRL - 7 TRL - 8 TRL - 9

TRL 7 - system prototype demonstration in operational environment.

TRL 9 - actual system proven in operational environment.

³ Sinha et al., 1990

2.4 Water-chemistry/column testing

At hydrothermal vents near the oceanic ridges, new oceanic crusts are being formed through the divergence of two tectonic plates. At these vents, the so-called black and white smokers (metal and sulphur rich mineralised type of chimneys) react with sea water. Because of the very high temperatures of the hydrothermal fluids, a chemical reaction takes place causing the metals such as copper, zinc, and iron to fall back down the seabed forming mineral deposits. These deposits are called polymetallic (massive) sulphides.

Because of these chemical processes taking place near these vents and deposits, as shown in the figure below, testing the chemical composition of the water can reveal information about the presence of such deposits.

Figure A.4.2.8 Chemical processes at hydrothermal vents

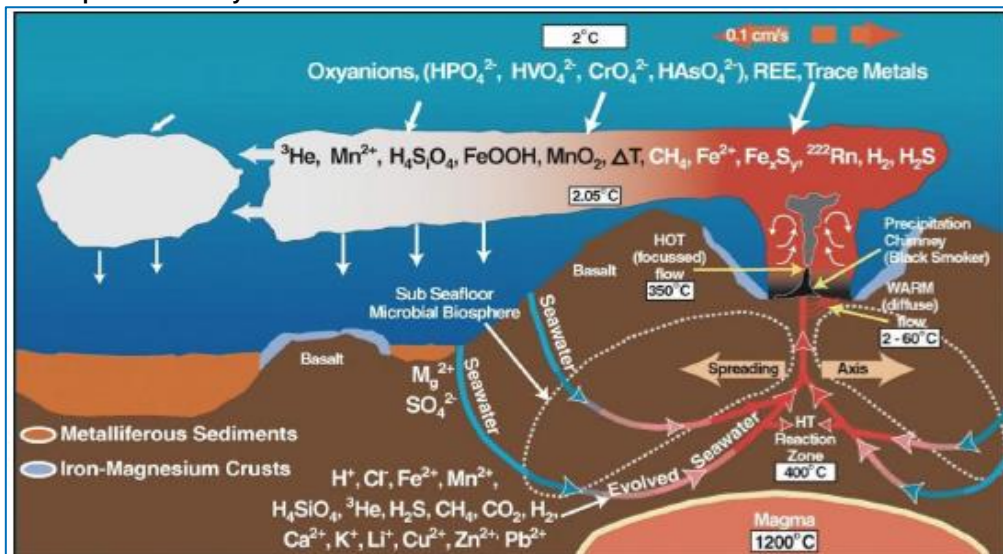

Source: <http://www.pmel.noaa.gov/eoi/chemistry/images/plume2.gif>.

In order to trace the ‘natural pollution’ caused by the active hydrothermal vents, the plume generated is possible to track with Conductivity, Temperature, and Depth (CTD) rosettes as shown below. The CTD rosette is a round metal frame with 24 plastic canisters, usually referred to as bottles, attached. Operators can trigger these to close individually at desired depths. This allows teams to retrieve samples from multiple depths during a single deployment for later analyses on the ship or back at shore labs. This makes it possible to characterize the whole water column if needed, or researchers might focus on specific depths that coincide with other work they are doing⁴.

A variety of sensors are also attached to the frame to provide a running flow of data back up to the ship about the waters below. This information can be useful on its own, or might be needed to help better understand conditions where specific water samples are collected. The basic sensors are for conductivity (salinity), temperature, and depth—those are the CTD in the name. But a variety of other equipment might also be attached such as oxygen sensors. Sea water samples of ‘natural pollution’ from up to 10km away can lead to locating the “active” metal vents.

⁴ Schmidt Ocean Institute, 2014.

Figure A.4.2.9 Water column testing equipment

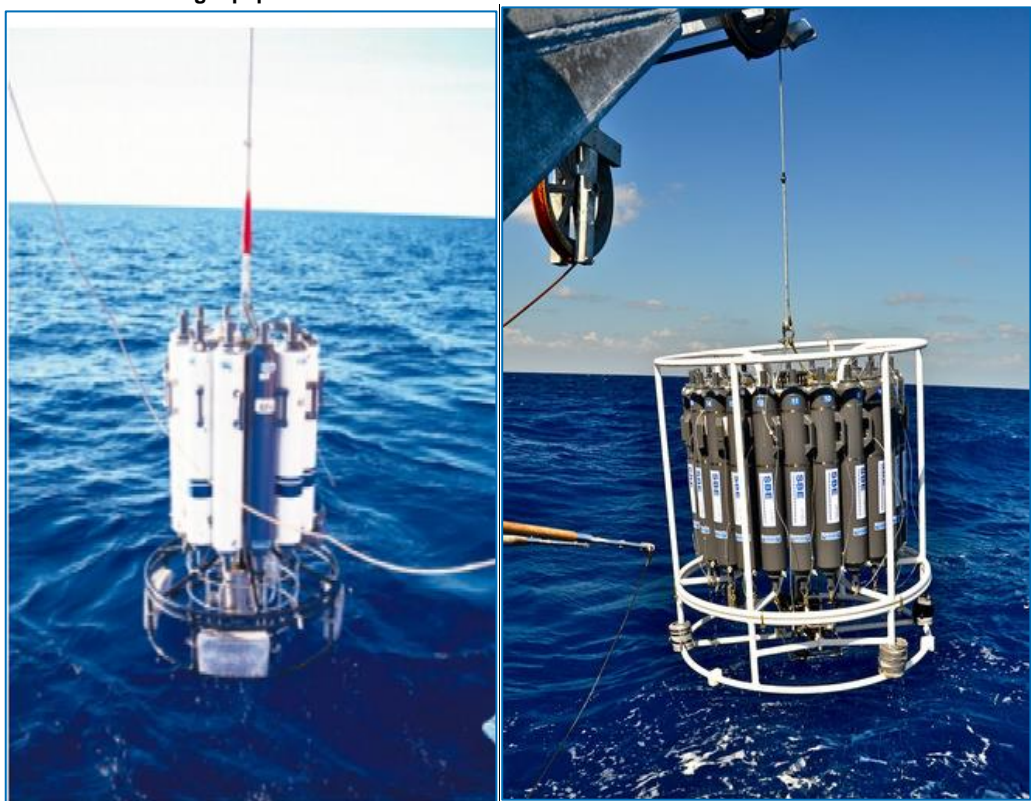

Source: Nautilus, 2012 and Schmidt Ocean Institute, 2014.

Companies

- Nautilus (Operator - Canada);
- Schmidt Ocean Institute (Research Institute -US);
- Sea Bird electronics (US);
- Caley Ocean Systems (CTD launch systems – UK).

Technology readiness level

The technologies and knowledge is so far mainly restricted to active vents, in order to trace inactive vents as well, new technologies and research is required.

Technological Readiness Level

TRL -	TRL -	TRL -	TRL -	TRL -	TRL -	TRL -	TRL -	TRL -	TRL -
1	2	3	4	5	6	7	8	9	9

TRL 9 - actual system proven in operational environment.

2.5 Autonomous underwater vehicle (AUV)

AUVs are commonly used in subsea oceanographic investigations and may be deployed with a range of sensors (bathymetry, side-scan, photo/video, or other) to gather data about properties of sea water and the seabed. It does not require input from an operator.

Figure A.4.2.10 Example of the Teledyne GAVIA AUV

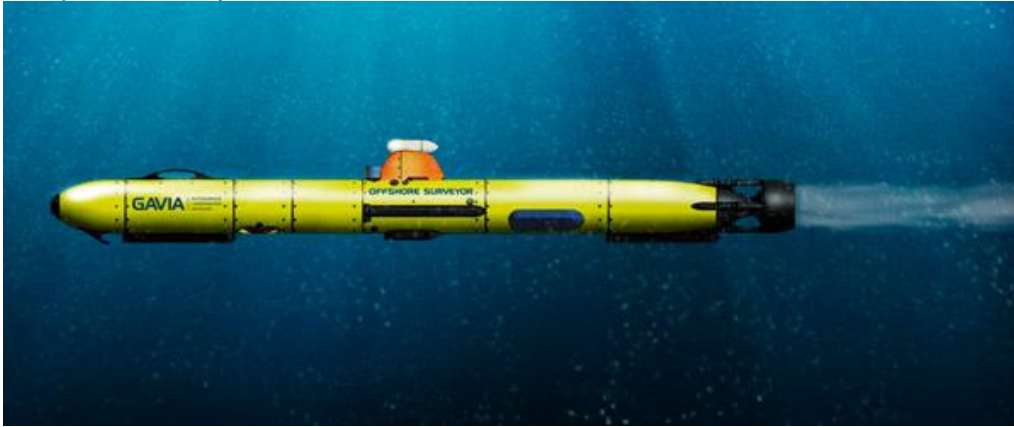

Source: Teledyne Benthos.

AUVs are often equipped with echo sounders and various measurement sensors, often depending on the purpose of the exploration. Some AUV's are therefore built upon several modules. Additionally, AUVs can be configured as tow-vehicles to deliver customized sensor packages to specific locations, and return to the ship after a deployment of about 20 hours.

As described earlier, AUVs are used to explore more precisely the morphology of the seafloor. High resolution images can be derived this way, compared to ship-mounted systems. Therefore, AUVs are used within the more targeted phases for exploring and determining the coverage of seafloor massive sulphides, crusts and nodules.

Companies – overview

- Kongsberg (NO);
- Teledyne Benthos (US);
- Bluefin Robotics (US);
- International Submarine Engineering (ISE) Ltd (CAN);
- FESTO (DE);
- Evologics (DE);
- University of Southampton (UK – Research institute).

Technology readiness level

AUV's are ready for deep sea usage and replace many of the ship-mounted systems. However, there is still potential for further development in software integration between different systems, applying new sensors and longer endurance and accuracy. Especially regarding long range capability and work to 6000 m depths research institutes are working with these vehicles as well. A specific addition to an AUV could be the gravity gradiometer to improve exploration outcomes in terms of discovering SMS systems with significant resource size potential. This will require a gravity gradiometer to identify the more significant subsurface metal accumulations of economic significance. Gravity gradiometers exist, and have been commercialised onto airborne platforms for terrestrial exploration. They require miniaturisation to fit on AUV.

Technological Readiness Level

TRL - 1 TRL - 2 TRL - 3 TRL - 4 TRL - 5 TRL - 6 TRL - 7 **TRL - 8** TRL - 9

TRL 8 - system complete and qualified

2.6 Remotely operated vehicle (ROVs)

A ROV is a tethered underwater vehicle. ROVs are unoccupied, highly manoeuvrable and remotely operated by a person aboard a vessel shown. They are linked to the ship by a tether (sometimes referred to as an umbilical cable), which is a group of cables that carry electrical power, video and data signals back and forth between the operator and the vehicle. High power applications will often use hydraulics in addition to electrical cabling. Most ROVs are equipped with at least a video camera and lights.

Additional equipment is commonly added to expand the vehicle's capabilities. These may include sonars, magnetometers, a still camera, a manipulator or cutting arm, grabbing arms, water samplers, and instruments that measure water clarity, light penetration and temperature⁵

The ROV should therefore be considered as instrument for several activities such as sonars, electromagnetics, water chemistry testing, sampling and small scale drilling.

Figure A.4.2.11. Examples of ROV's



Source: Odyssey and Ifremer.

ROVs have developed over the years and are both in use for commercial and scientific purposes. Today, several European countries have developed or acquired ROVs of different functionality. However, currently only a couple multipurpose ROVs and submersibles - which allow sampling and manipulation of tools at the deep seafloor - are available to European research programmes. Efficient elevator systems that relay material between the surface and the sea floor serve to maximise ROV time efficiency.

An example of the functionalities and technical specifications of IFREMER's (French Research Institute for the exploitation of the seas) ROV is provided in the table below.

Table A.4.2.2 Functionalities and specifications for ROV at IFREMER

IFREMER-ROV: VICTOR	specifications
Working depth	6,000 m
Thrust	200 kg in all directions
Speed	1.5 knots
Cameras	1 main 3-CCD camera with zoom and direction-finder
	2 piloting cameras

⁵ University of Southampton, 2012

IFREMER-ROV: VICTOR	specifications
	5 additional colour cameras
Lighting	8 flood lights totalling 5 kW
Sensors	attitude
	pressure depth
	altitude
	sonar
	log
Manipulators	one 7-function manipulator arm, lifting 100 kg
	one 5-function grasping arm, lifting 100 kg
Variable ballast system	70 litres at 2 litres/mn at 600 bars

Source: Ifremer, 2014.

Company – overview

Perry Slingsby Systems (ROV manufacturer – UK);
 Soil Marine Dynamics (SMD – UK);
 Ifremer (FR – Research);
 MARUM (DE – Research);
 NOC (UK – Research).

Technology readiness level

ROVs are well developed systems being currently deployed at depths of around 6000m and ROVs are developed at the moment to reach depths up to 11.000m.

Technological Readiness Level

TRL - 1 TRL - 2 TRL - 3 TRL - 4 TRL - 5 TRL - 6 TRL - 7 TRL - 8 TRL - 9

TRL 9 - actual system proven in operational environment.

3 Technology assessment: Sampling

A geophysical anomaly can be 'ground truthed' to confirm the source of the anomaly is in fact sulphides/nodules/crusts and also to determine the style and surface grade of mineralisation. A sample is taken from the seafloor which can be evaluated later on board.

Identified technologies available for sampling include:

- Free fall devices;
- Grab samplers;
- Box corers;
- Gravity corers;
- Piston corers;
- Vibrocoreing.

Many of the above mentioned techniques are well developed and have been in use for the exploration of oil and gas engineering, dredging, pipeline surveys and oceanographic research.

3.1 Free-fall devices

Free-fall devices can descend to the bottom, take samples and photographs and return to the surface on their own. A few kilograms of nodules can be collected from an area of 0.25 m² in each dive, and pictures covering 2-4 m² can be taken.

The device, released from the surface descends independently thanks to its additional weight. The journey from surface to bottom varies from 2 to 4 hours for a depth of 4 to 5,000 m. It automatically performs sampling as from bottom contact (sampling an area of 0.18 m) at the water-sediment interface, takes a slightly oblique picture about 1 m² the sea bottom and, then, in releasing its weight, begins its return to the surface.

On its appearance at the surface, it is located by the presence of a flag and night flash as well as direction finding through a radio beacon.

Figure A.4.3.1. Free-fall device

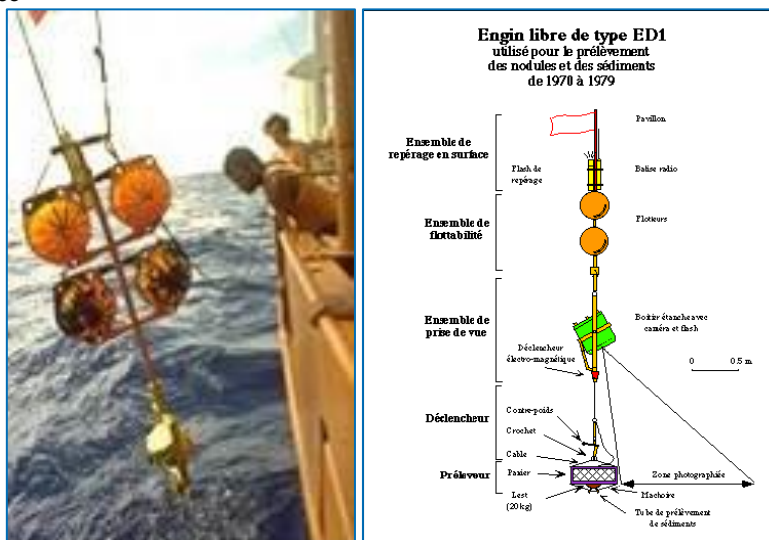

Source: Ifremer.

The device is often only used for nodule sampling, as the sample can only be recovered from the direct seabed. This is a low cost sampling alternative. It is a mechanical device with little electronics and relatively easy to use. Their location on the surface and their recovery take place quickly and successfully. Can be released and recovered at night.

A disadvantage is the random positioning. It can often only sample part of the surface, and is often unable to collect the biggest of nodules and may lose the smaller nodules. Accordingly, the results of the evaluations of the quantity of nodules will be less than the reality. It can operate up to 3000m.

Company – overview

- Duncan and Associates (UK);
- Kahl Scientific Instrument Corporation (US);
- KC Denmark (DK);
- Sevmorgeo (RUS);
- Fugro (NL – operator).

Technology readiness level

The device is in use already since the 70s and has been used for sampling nodules in a deepsea environment.

Technological Readiness Level

TRL - TRL - TRL - TRL - TRL - TRL - TRL - TRL - TRL -

1 2 3 4 5 6 7 8 9

TRL 9 - actual system proven in operational environment.

3.2 Grab samplers

Grab samplers are one of the most common methods of retrieving soil samples from the seabed surface. Different than the free fall device, the grab sampler is connected with the vessel or operated by an ROV. Rough samples can be collected from the target areas. A grab sampler can be used for sampling of nodules, but also for SMS. The grab sampler is limited to taking samples at

only the surface of the seafloor. A drawback compared to for instance a box corer is that a grab sampler disturbs the sediments more.

Grab samplers can also be deployed from ROVs.

Figure A.4.3.2 Several applications of grab samplers



Source: Nautilus, 2012 and SoundOcean.

Company – overview

- Duncan and Associates (UK);
- Kahl Scientific Instrument Corporation (US);
- KC Denmark (DK);
- Sevmorgeo (RUS);
- Uwitec (AU);
- Fugro (NL – operator).

Technology readiness level

Grab samplers are developed to reach depths of around maximum 6000m. They are in use for scientific and commercial purposes.

Technological Readiness Level

TRL - 1	TRL - 2	TRL - 3	TRL - 4	TRL - 5	TRL - 6	TRL - 7	TRL - 8	TRL - 9
---------	---------	---------	---------	---------	---------	---------	---------	---------

TRL 9 - actual system proven in operational environment.

3.3 Box corers

The box corer is deployed from a vessel through a deep-sea wire and is similar to the grab sampler in its functionality. A spade is used to take the sample from the seafloor, operated within a 'box'.

The corer is lowered vertically until it impacts with the seabed. At this point the instrument is triggered by a trip as the main coring stem passes through its frame. The stem has a weight of up to 1500 kg to aid penetration. While pulling the corer out of the sediment a spade swings underneath the sample to prevent loss. When hauled back on board, the spade is under the box. This mechanism is illustrated in the figure below.

Figure A.4.3.3 Box corer mechanism

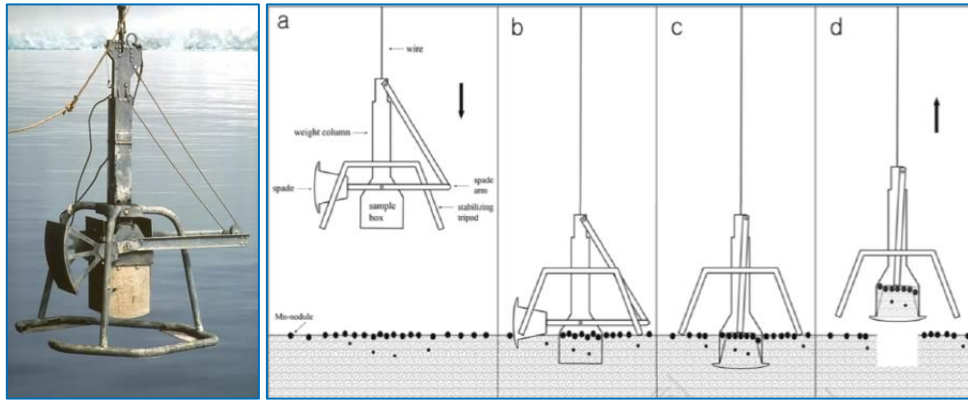

Source: Lee et al, 2008.

The box corer is merely used for taking samples of polymetallic nodules, as it is limited to take a sample of 50cm deep.

Company – overview

Duncan and Associates (UK);
 Kahl Scientific Instrument Corporation (US);
 KC Denmark (DK);
 Sevmorgeo (RUS);
 Uwitec (AU);
 Fugro (NL – operator).

Technology readiness level

Box corers are used in the operational environment of exploring for nodules.

Technological Readiness Level

TRL - 1 TRL - 2 TRL - 3 TRL - 4 TRL - 5 TRL - 6 TRL - 7 TRL - 8 TRL - 9

TRL 9 - actual system proven in operational environment.

3.4 Gravity corer

Gravity coring is the simplest method of obtaining a sediment sample from the seabed. Gravity corers provide a rapid means of obtaining a continuous core sample in water depths down to several thousand metres. A corer consists of a weight with steel tube sections attached to it. The weight can vary between 100kg to 1000kg. The length of sample tube is selected according to the type of sediment being sampled and is generally between one and four metres. The corer is lowered down to the sea bed on the end of a wire, stopping a set distance above. It is then lowered at a set speed into the sediment. The corer is then raised to the surface, dismantled and the polycarbonate core liner encasing the sample is removed⁶).

Gravity corers are only really appropriate for use in very soft to firm clays, as penetration in stiffer clays or sands is usually limited. It can be used to take samples of seafloor massive sulphides targeted areas.

⁶ Fugro, 2001

Figure A.4.3.4 Gravity corer deployed from the USCG Healy

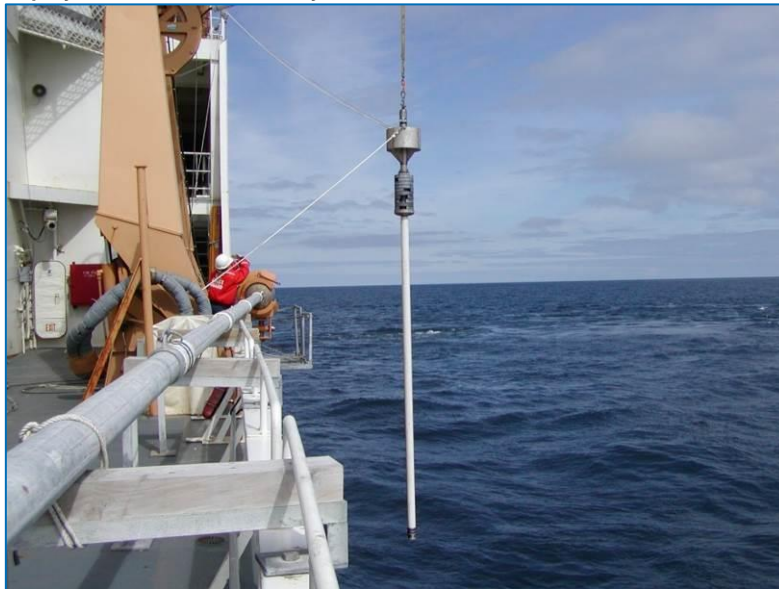

Source: USCG

Companies – overview

Duncan and Associates (UK);
Kahl Scientific Instrument Corporation (US);
KC Denmark (DK);
Sevmorgeo (RUS);
Uwitec (AU);
SEAS (AUS);
Fugro (NL – operator).

Technology readiness level

Gravity corers are used in the operational environment of exploring for seafloor massive sulphides.

Technological Readiness Level

TRL - TRL - TRL - TRL - TRL - TRL - TRL - TRL - TRL -
1 2 3 4 5 6 7 8 9

TRL 9 - actual system proven in operational environment.

3.5 Piston corers

A piston corer uses a "free fall" of the coring rig to achieve a greater initial force on impact than gravity coring, and a sliding piston inside the core barrel to reduce inside wall friction with the sediment and to assist in the evacuation of displaced water from the top of the corer. Samples from piston corers allow for more detailed soil sequencing and more accurate strength analysis. The core barrels are in lengths of up to 30 meters and can realize a sample depth of that similar size.

The piston corer, when correctly designed and operated, can produce good quality samples in soft soils. The long, deep water, piston corers can, in some cases, eliminate the requirement for a drilling vessel and, in theory, be deployed from a wide range of vessels. However, the realization of a safe and efficient operation requires the use of large well-equipped vessels and, usually, the

mobilization of a high capacity deployment winch and handling system together with structural modifications to the vessel⁷.

Figure A.4.3.5 Piston coring mechanism



Source: Woods Hole Oceanographic Centre.

Companies – overview

Duncan and Associates (UK);
 Kahl Scientific Instrument Corporation (US);
 KC Denmark (DK);
 Uwitec (AU);
 SEAS (AUS);
 Fugro (NL – operator).

Technology readiness level

Piston corers are used in the operational environment of exploring for seafloor massive sulphides. They have been used for many other oceanographic exploratory studies already since the 50s.

Technological Readiness Level

TRL - TRL - TRL - TRL - TRL - TRL - TRL - TRL - TRL -
 1 2 3 4 5 6 7 8 9

TRL 9 - actual system proven in operational environment.

3.6 Vibrocoring

When soil conditions are unsuited to gravity corers or where greater penetration of the seabed is necessary, vibrocoring is an option. Vibrocoring is used widely throughout the geotechnical

⁷ Fugro, 2001

investigation industry and can be deployed in water depths up to 3,000m, with a core length of around 3-6meters.

To penetrate soils such as dense sands and gravels, or to reach deeper into stiff clays, rather than depending on a gravity free-fall, the corers barrel is vibrated thus facilitating its penetration. In other respects, the barrel and sample retention systems are similar to gravity corers⁸

Figure A.4.3.6 Vibracorer on board



Source: Boskalis, 2013.

Because of their size and power demands, substantial sized ships are required. Further, because coring is a protracted process, the ship must be capable of remaining on station and will preferably either have dynamic positioning (DP) or good joy-stick control otherwise excessive position excursions may cause the core barrels to bend, which may lead to a total loss of the system and other financial loss through downtime.

Company – overview

SEAS (AUS);
 UTEC Geomarine (UK);
 Fugro (NL – operator).

Technology readiness level

Vibrocorers are used in the operational environment of exploring for seafloor massive sulphides. They have been used for many other oceanographic exploratory studies and oil&gas industry.

Technological Readiness Level

TRL - TRL - TRL - TRL - TRL - TRL - TRL - TRL - TRL -
 1 2 3 4 5 6 7 8 9

TRL 9 - actual system proven in operational environment.

3.7 Technology assessment: Drilling

Drilling is a form of sampling, but generally deeper and on a more systematic basis. It is only applicable for seafloor massive sulphides, as these do not exist on the seafloor, but deeper below. Through drilling, the best seafloor massive sulphides prospects are advanced to resource status. The systematic drills on a defined area allow for a three-dimensional estimate to be made of the

⁸ Fugro, 2001

deposits size of seafloor massive sulphides. Drilling assists in determining the average grade of the deposits as well.

Drilling requires many holes to be made in order to allow for a proper estimate to be made of the deposits size. A possible systematic is outlined below, which is an example proposed by Nautilus.

Figure A.4.3.7 Drill holes in an early exploratory and pre-mining phase.

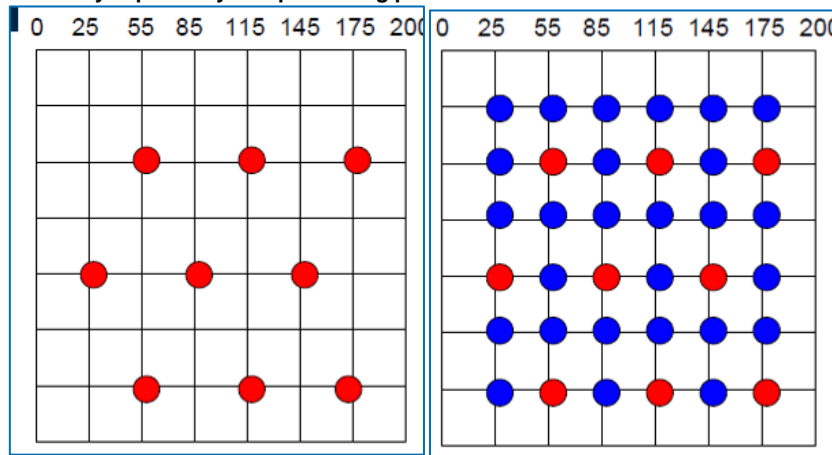

Source: Nautilus, 2004.

On the left of the picture, the drill program is outlined for first phase exploration. Within an area of 200x200 meters, 9 holes are drilled with 60 meters spacing and at 20 meters depth. When these samples provide consistent grades, one can scale up drilling to 27 holes (on the right) with only 30 meters spacing. Within the Solwara 1 project, Nautilus drilled in 2006 first 42 holes, achieving a grade of on average 41%, but the recovery of sediment was rather poor. In 2007, Nautilus scaled up to 111 drillings, achieving a 70% core recovery and enough base for resource estimation⁹.

The drilling techniques are similar to sampling, however not all sampling techniques can achieve the depth of around 20m which is required for drilling. In addition, accuracy is necessary for reliable estimates. The available techniques can be groups into:

- Piston corers (similar to sampling);
- Drill rigs;
- Ship based drills.

3.8 Drill rigs/ROV based drills

Drill rigs are portable drilling systems, operated from the vessel. There are currently rigs available to achieve water depths of 4000m below surface and with 200 meters below seafloor. Drill rigs are operated on a stable platform on the seabed which preserves any disturbing effects from vessel or wave movements.

⁹ Golder Associates, 2008

Figure A.4.3.8 BAUER Drill Rig



Source: Bauer Maritime Technologies.

First-generation Rovdrill systems and support spreads had certain limitations. During the previous campaigns in 2007 and 2008 of Nautilus, a number of holes were terminated prematurely—often considerably short of target depth—due to hole collapse. Steeply sloping terrains at the drill sites and reliability of the drill rig affected long-term productivity.

As a result of these operational constraints, large areas at Solwara 1 remained undrilled. The results from other geophysical investigations and surveys performed previously and concurrently with the drilling programs, particularly electromagnetic surveys, inferred that the depth of the ore body on Solwara 1 could be considerably greater than that indicated by the core sample recoveries.

Drilling remains a very critical and challenging operation. Increasing productivity and improving core recovery developments are necessary for drilling operations.

Companies

- BAUER (DE);
- British Geological Survey (UK – operator/research);
- Perry Slingsby Systems (US);
- Nautilus (Operator, CAN).

Technology readiness level

Drill rigs are used in the operational environment of exploring for seafloor massive sulphides. They have been used for other oceanographic exploratory studies as well. However, increased reliability, productivity and core recovery quality seems necessary.

Technological Readiness Level

TRL -	TRL -	TRL -	TRL -	TRL -	TRL -	TRL -	TRL -	TRL -
1	2	3	4	5	6	7	8	9

TRL 9 - actual system proven in operational environment.

3.9 Ship based drills

Drills can also be done through drilling operations from a vessel. There are only a couple of such vessels active in the world, reaching depths up to 2,500 meters. The drills are motion-compensated thus providing a "stationary" drill string in relation to the seabed. One of the most recent orders of these vessels is the Gusto Magellan, which can reach depths of even 4,500 meters.

Figure A.4.3.9 Fugro Seacore drilling vessel



Source: Fugro

So far, these vessels have not yet been able to achieve the same depths as Drill rigs and ROVs. Therefore they have not yet been used that much for seafloor massive sulphides exploration. The latter are also more flexible to operate. However, ship based drills may have the potential to achieve greater depths in the seafloor.

Company – overview

- Fugro (NL);
- GustoMSC (NL);
- Huisman (NL);
- Maersk (DK);
- Noble (UK).

Technology readiness level

Technological Readiness Level								
TRL -	TRL -	TRL -	TRL -	TRL -	TRL -	TRL -	TRL -	TRL -
1	2	3	4	5	6	7	8	9

TRL 6 - technology demonstrated in relevant environment.

4 Resource Assessment, Reserve Evaluation and Mine Planning

4.1 Introduction into the project planning phase

The phase of resource assessment, reserve evaluation and mine planning is the essential project planning phase, where exploration data are synthesized in a numerical 3D resource model and its uncertainty is assessed. Intermediate results lead to an estimate of geological in-place resources.

During reserve estimation strategic-, long- and medium term mine planning decisions are derived with its associated investment and operating costs. At the feasibility level critical aspects including mining technological and metallurgical, economic, marketing, legal, environmental, social and governmental factors are assessed and a quantitative assessment of recoverable reserves.

Figure A.4.4.1 Activities within the project planning phase

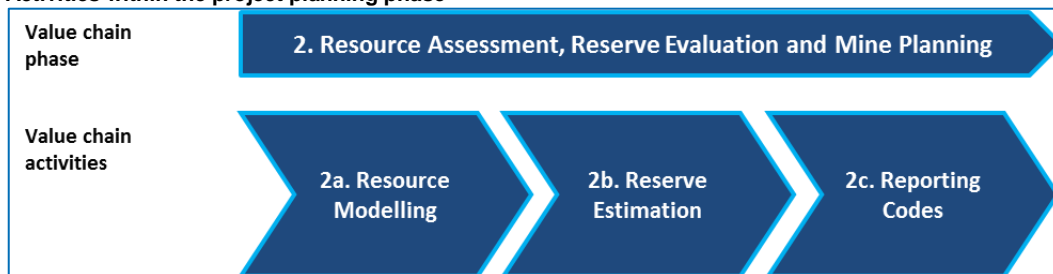

Results of resource assessment and reserve estimation are documented and reported for stakeholders and investors according international reporting standards, e.g. the JORC code. The use of this code is standard for all conventional/terrestrial mining business cases. However the only deep sea project to have attempted this is Nautilus. They achieved to report indicated resources¹⁰.

Figure A.4.4.2 International Reporting Standard (e.g. JORC, 2012)

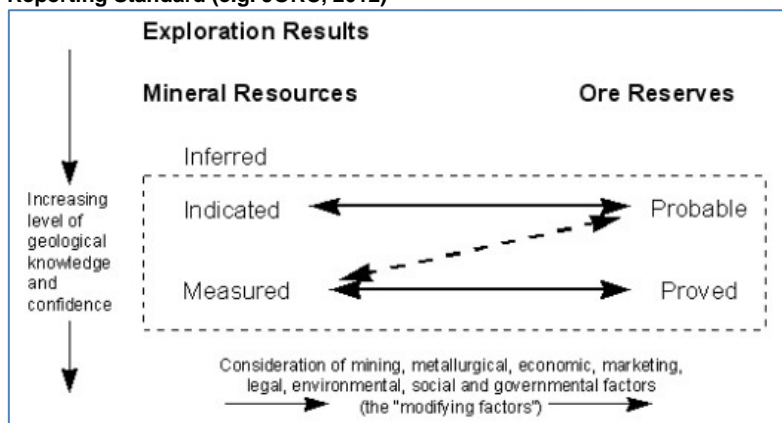

4.2 Technology assessment: Resource Modelling

Based on the exploration activities and retrieved sample and drilling data, the resources are modelled in order to estimate the geological resources in place.

¹⁰ Golder Associates (2012), Mineral resource estimates Solwara project, 23 March 2012.

The identified potential modelling techniques include:

- 3D Geometallurgical Modelling (for seafloor massive sulphides);
- 2D Multivariate Modelling (for nodules and cobalt-rich crusts).

4.3 3D Geometallurgical Modelling of seafloor massive sulphides

The value carrying ore-types in seafloor-massive-sulphides are spatially distributed in all three dimensions. This requires a full 3D resource model capturing both the geological structure and the spatial grade distribution inside the different rock zones. To comply with International Reporting standards, modelling techniques should be designed to provide beside the local estimate as well a realistic quantitative assessment about the uncertainty in estimation.

Currently the availability of direct drilling) data has prevented spatial modelling of seafloor massive sulphides. A solution is to incorporate indirect data, such as areal measured geophysical data including seismic and electric relevant properties. To further support the reliability of the models the integration of expert knowledge about the associated geological processes is necessary.

This leads to the following requirements for an integrated 3D Geometallurgical Modelling technique:

- 3D techniques modelling the spatial variability and uncertainty of geological structures;
- 3D techniques modelling the spatial variability and uncertainty of grades, extractability and processing relevant properties;
- Methods should be designed as algorithm integrating scarce direct, highly dense indirect measurements and expert knowledge about geological processes.

The requirements described above are not met in one consistent method. Modelling of geology based on expert knowledge is known in reservoir engineering using Multi-point statistical methods¹¹ or high order statistics¹². Methods for simulating linear properties are state of the art and include classical sequential Gaussian simulation¹³ or the generalized sequential Gaussian Simulation¹⁴. Both methods are available as well for integration of secondary data¹⁵ However the computational stability and performance for the case of a large secondary data density compared to direct data has to be further evaluated. Process based modelling may be based on compositional data analysis using log ratios of data.

Further research is required to transfer these concepts to a consistent framework applicable in a deep sea environment.

EU Companies – overview:

Companies for implementing Modelling Techniques in commercial software include:

Geovariances (France);
gOcad (France);
Dessault/Geovia (UK).

Technology readiness level

3D spatial Modelling need to be adapted to account for multiple data sources (direct and indirect) + Geometallurgy

¹¹ Strebelle, 2010

¹² e.g. Dimitrakopoulos et al

¹³ Isaaks 1989

¹⁴ Benndorf and Dimitrakopoulos, 2007

¹⁵ Boucher, 2009

Technological Readiness Level

TRL - TRL - TRL - TRL - TRL - TRL - TRL - TRL - TRL -
1 2 3 4 5 6 7 8 9

TRL 3 - experimental proof of concept.

4.4 2D Multivariate Modelling

Polymetallic nodules and cobalt rich crusts can be characterized as a 2D object with associated attributes, such as abundance, thickness or metal grades. Direct or indirect sampling techniques are available. The data basis is evaluated as sufficient for modelling the spatial distribution and its associated uncertainty can be modelled using available techniques.

Company – overview

Companies for implementing Modelling Techniques in commercial software include:

Geovariances (France);

gOcad (France);

Dessault/Geovia (UK).

Technology readiness level

TRL 9 - experimental proof of concept.

Techniques are already commercially available. No further development needed.

Technological Readiness Level

TRL - TRL - TRL - TRL - TRL - TRL - TRL - TRL - TRL -
1 2 3 4 5 6 7 8 9

TRL 9 - actual system proven in operational environment.

4.5 Procedural assessment: Reserve Estimation and Mine Planning

Utilizing 3D Resource Models, recoverable reserves need to be evaluated, processes planned on a strategic-, long-, medium and short-term basis. The actual duration of this stage depends on the complexity of the project: geometry, spatial distribution & continuity of the deposit, variation in metal content, grades, differences in processing recoveries. A proper assessment requires comprehensive resource – reserve assessment data, the formulation of a sequential mine plan, mine layout, and needs to incorporate anticipated metal recoveries versus CAPEX & OPEX. The latter also needs to incorporate marketing, legal, social and governmental factors.

4.6 Long-Term Deep-Sea Mine Planning

For a comprehensive long-term mine planning process all boundary conditions including:

- mining license area;
- mining technology;
- processing technology;
- available space for waste disposal;

- environmental impact;
- capital and operational expenditures;
- necessary permits.

Need to be understood fully. The subsequent design and optimization process includes the definition of an ultimate pit, mining phases, smallest minable units and selectivity, annual production of waste and ore, annual usage of space, annual reclamation and environmental impact mitigation actions¹⁶ Based on the previous detailed studies capital and operational expenditures (CAPEX and OPEX) can be estimated on an annual basis leading to financial project performance indicators.

At the current state it is not possible to conduct a long-term mine planning process leading to proven reserves. In combination with resource modelling, mine planning standards for deep sea mining have to be developed reflecting capabilities of machines and can be seen as a platform integrating all modifying factors including mining technological and metallurgical, economic, marketing, legal, environmental, social and governmental factors.

Company – overview

Any mining consulting company, such as:

SRK Consulting (UK);

Golders (UK);

MTI Holland (The Netherlands);

MIBRAG Consulting International (Germany).

Technology readiness level

Deep-sea geotechnical site investigation and evaluation methods and procedures for pit design, including slopes and ground conditions as well as for predicting extraction efficiencies¹⁷) are subject of current research, however need to be validated in lab and real environment. Established standard procedures for site investigation and evaluation from related off-shore disciplines, such as sub-sea trenching, dredging or oil and gas¹⁸ can be used as basis for developing deep sea mining specific methods.

Technological Readiness Level

TRL - TRL - TRL - TRL - **TRL -** TRL - TRL - TRL - TRL -
 1 2 3 4 5 6 7 8 9

TRL 5 - technology validated in relevant environment (industrially relevant environment in the case of key enabling technologies).

4.7 Medium- and Short-Term Deep-Sea Mine Planning

Medium and short-term mine production plan typically expands one to three years with a monthly down to a weekly resolution. It takes into account the defined development sequences, production characteristics, quantities and rates from the Life of Mine Plan. These rates are validated against production capacity constraints, for example due to planned maintenance activities. The result is a feasible mining production plan. A critical component of the short-term mine plan is the capacity.

¹⁶ e.g. Hustrulid and Kuchta, 2004.

¹⁷ Miedema, S.A., Zijssling, Dj., "Hyperbaric Rock Cutting". OMAE 2012, Rio de Janeiro, Brasil, June 2012.

¹⁸ Bai Y. and Bai Q. (2010) Subsea Engineering Handbook. Gulf Professional Publishing, New York, 919 pp.

The capacity is the product of:

- effective production rate; and
- effective operating time.

The effective production rate is determined by the equipment specifications and the medium to cut or transport. The effective operation time depends on scheduled hours, technical availability, maintenance strategy and operational processes (see figure below)

Figure A.4.4.3 Effective operating time

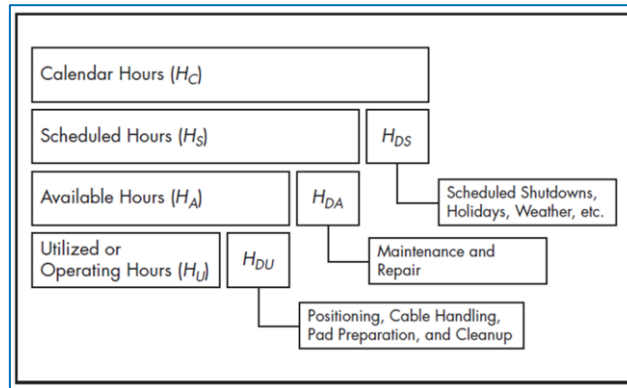

Both critical items: effective production rate and effective operating time are understood only with a very low level of confidence (+/-60%). Reasons are:

- missing understanding on cutting effectiveness in deep sea conditions (hydrostatic pressure in 4km-6km depth);
- detailed understanding of auxiliary processes for a deep sea mining operation are not understood, including:
 - site preparation;
 - deep sea maintenance (scheduled and break down) and preparation: mechanical and electrical;
 - operational processes such as cable handling;
 - short-term sequencing, ore blending and grade control;
 - options of pre-upgrading;
 - direct waste material handling.

These points involve only some selected aspects to be considered. Depending on the mining system chosen further work has to be dedicated to deep-sea mining system simulation to understand the available time fond. Please note that the uncertainty in time fond directly influences operational costs and is this linearly linked to uncertainty in expected cash flows.

Companies – overview:

Mining Consultants and Mining Operators.

Technology readiness level

Technological Readiness Level

TRL -	TRL -	TRL -	TRL -	TRL -	TRL -	TRL -	TRL -	TRL -
1	2	3	4	5	6	7	8	9

TRL 3 - experimental proof of concept.

Comparison with land-based techniques for pre-processing

Potential resources for analogies include off-shore engineering, maintenance concepts, time funds, operational handling experiences can be used as a prior guess for inputs in short term planning. However, the physical extraction of deep-sea resources is a material ware intensive process. A large focus has to be out on deep-sea maintenance strategies. Due to high investment and operating costs the system reliability is essential. Reliability centred maintenance concepts as applied for maintaining airplanes or in large continuous mining systems should be adapted and proven in a deep-sea environment.

4.8 Resource/Reserve Reporting Codes

Investment decisions of shareholders in the mining industry are based on a transparent documentation of project value expected, which links the level of uncertainty and technical depth with the corresponding risk of achieving expected profit margins and sustainable project performance including environmental impact, social impact and economics. For the land based mineral resource industry international standards are developed and globally accepted including the JORC –Code (JORC, effective 2012; Australia) or the NI 43-101 (National Instrument 43-101, effective 2011; Canada). These standards provide guidelines for minimum requirements with respect to documenting and reporting exploration results, mineral resources and mineral reserves. The general classification scheme is provided in Figure A.3.2.2.

Seafloor massive sulphides exploration differs profoundly from traditional mineral exploration in one 'visible ore bodies'.

The upper surfaces of the seafloor massive sulphides mound is generally 'un-buried' leaving it open for detailed imaging using sidescan sonar and other conventional imaging methods using ROVs, AUVs. The in-depth resource delineation and spatial characterization using exploration drill holes appears currently difficult¹⁹). In addition to the information type, quality and content the sizes of currently known deposits differs significantly from land-based equivalents, impacting the ratio of investment and operational costs and hence the project risk. These aspects will require amendments to be made to various resource definition codes and the methods defining Indicated and Measured resources e.g. Australia's JORC Code.

Company – overview

Organisations that are responsible for developing mineral reporting codes, grouped e.g. in the CRIRSCO (Committee for Mineral Reserves International Reporting Standards).

Technology readiness level

Technological Readiness Level

TRL -	TRL -	TRL -	TRL -	TRL -	TRL -	TRL -	TRL -	TRL -
1	2	3	4	5	6	7	8	9

TRL 5 - technology validated in relevant environment (industrially relevant environment in the case of key enabling technologies).

¹⁹ e.g. Melnic; 2001

5 Extraction, lifting and surface operations

5.1 Introduction into extraction, lifting and surface operations

After resource assessment, reserve evaluation and mine planning the next phase in the value chain is excavation and materials handling. This phase covers the liberation of the minerals (excavation or collection) from the seafloor, pre-processing of the ore on the seafloor, dispatching and vertical transportation to surface and any surface operations prior to shipping of the material to shore.

Many of the techniques to be used during this phase are concepts and have not been built or tested in practice. It is noted that there has not been any large scale extraction till date so there is not market yet to share. There are no production systems: only models or “concepts”. There is no market share. For example Aker Wirth plans to implement a system in 2020 for Mn nodule extraction. Nautilus has commissioned 1 cutter. We don’t think there is public information available on state of the art in China etc.

Some techniques assume modifications of existing techniques that are being applied in terrestrial surface mining, land based mineral processing or the offshore oil & gas and marine aggregates industry.

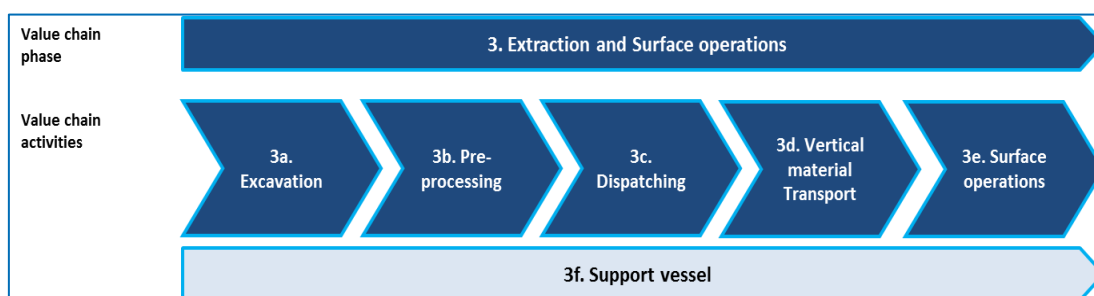

5.2 Technology assessment: Excavation

Although the development of deep-sea mining excavation machinery has only resulted in a limited amount of real equipment to date, research projects were conducted over the last decades resulting in multiple conceptual excavation techniques. With the applicable excavation techniques largely depending on the ore type this section will provide an overview of these techniques accordingly.

Ores	Identified Excavation Techniques		
Polymetallic Sulphides (seafloor massive sulphides)	Drum-cutter ROV	Rotating-cutter head ROV	ROV Clamshell grab
Polymetallic Nodules	Passive Collectors	Active Collectors	
Cobalt-rich Crusts	None to date		

5.3 Polymetallic Sulphides (seafloor massive sulphides)

Seafloor massive sulphides deposits present several challenges for extraction technology. First, the ore body is comprised of a combination of loose material such as fallen chimneys, and solid fused minerals such as re-crystallized sulphides and deposition layers. Second, the seafloor terrain may be rugged due to tectonic activity²⁰.

Extraction technology for the mining of polymetallic sulphides has been adapted from that used in deep-ocean petroleum operations, such as seabed pipe trenching operations, and from offshore placer diamond mining, the latter of which is being adapted from shelf-depth operations to deep-water operations²¹.

Polymetallic sulphides rock has been shown to have strength properties similar to coal and as such, terrestrial coal mining techniques form the basis for the design of seafloor mining equipment²².

5.3.1 Drum-cutter ROV (+ collector) – seafloor massive sulphides

Figure A.4.5.1 Conceptual Drum-cutter ROV (left) and Auxiliary cutter ROV (right)

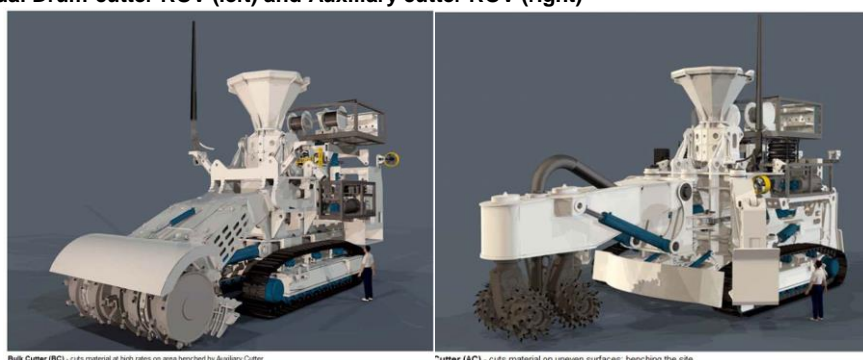

An example of the drum-cutter concept is presented in the figure above. Proposed by Nautilus this design is based on methods used in terrestrial coal extraction. The electrically driven ROV is fitted with a drum-cutter and is moving over the seafloor on tracks. The cutting teeth on the drum are optimized to produce particles averaging 50mm in size whilst the production of ultra-fine particles is minimized.

The ROV is designed to create its own flat working surface “after one track length”. Whenever very uneven terrain is encountered a second auxiliary ROV may be required to flatten the seafloor prior to excavation with the drum-cutter ROV.

The drum cutter ROV is cutting the rock and the ore is either transported by a pump that is built into the ROV close to the cutter drum or the ore is left on the seafloor for a collector ROV that will collect the loosened ore and transports the material to the pre-processing or dispatch system on the seafloor.

Placer Dome Technical Services Ltd, a subsidiary of Barrick Gold and Nautilus Minerals Inc., conducted a technology test program in 2005 in support of the conceptual design of a subsea

²⁰ Herzig, P. (1999). Economic potential of sea-floor massive sulphide deposits: ancient and modern. London: Phil. Trans. R. Soc. London.

²¹ Hein et al. (2013). Deep-ocean mineral deposits as a source of critical metals for high- and green-technology applications: Comparison with land-based resources (Vol. 51). Santa Cruz: Ore Geology Reviews, Elsevier.

²² Jackson, E., & Clarke, D. (2007). Subsea Excavation of Seafloor Massive Sulphides. New Westminster, BC, Canada: Cellula Robotics Ltd.

mining system. As part of this test program a subsea excavator was fitted with a land based rock-cutting tool to investigate the ability of such a tool to cut rock at depths of 1600m. The results of this research project are used in the design of subsea excavators that will be used to mine the Solwara-1 ore deposit²³.

Construction of the Nautilus deep-sea excavation system started in 2007 by SMD but was put on hold in November 2012 as a result of a financing dispute between Nautilus and the state of Papua New Guinea.

Company – Overview

SMD - Soil Machine Dynamics (UK);

Nautilus Minerals (Operator – Canada);

Placer Dome Technical Services Ltd. (Barrick Gold & Nautilus Minerals - Canada);

Perry Slingsby Systems (ROV manufacturer – UK);

Voest Alpine (cutter/roadheader manufacturer – Austria).

The technology test program as conducted by Placer Dome Technical Services Ltd (PDTs) revealed that²⁴;

1. A land based rock-cutting tool could effectively cut the mineralized rock at ocean depths of 1600m;
2. Higher specific energies and cutting forces are required (for instance through hyperbaric cutting) and smaller rock chippings are produced compared to dry cutting conditions;
3. Regrinding of subsea rock due to inefficient material removal from the 'rock face' is considered a main contributor to the increased specific energy. Specific energies can be reduced if the material removal becomes more effective;
4. The hydrostatic pressure at depth does not seem to be a major factor in cutting performance.

Birney²⁵ notes that deep-sea plumes can be caused through the production of ultra-fine particles (<10 microns) where the cutter teeth meet the rock face. The crushing force of the tooth creates the fine material as a pressure bulb is formed between the tooth and the rock. Due to the open design of the drum cutter it may be difficult to handle the ultra-fine particles and minimize plume formation.

The initial tests results as obtained by PDTs are promising in terms of the application of the cutter-drum to loosen rock at the seafloor. The overall success of the technique will depend on.

The effective removal of material from the rock face and transportation into the subsequent ore handling system.

Due to the hydrostatic pressure at the seafloor ore does not fall off the rock face in the same way as in terrestrial mining. On land, after cutting the ore will immediately fall off of the rock face, as the atmospheric pressure is too low to hold the cuttings in place. Due to the pressure regime at depths of a few kilometres below sea-level, the cuttings will not fall off the rock face fast and as a result rock is being cut multiple times resulting in smaller cuttings and higher energy requirements for cutting.

The ability of the ROV to provide the necessary cutting force and power to cut the rock.

Both in terms of the weight on the cutter drum as well as power to drive the cutter drum. To increase the weight on the cutter drum requires the ROV to be very heavy. This increases the

²³ Jackson, E., & Hunter, J. (2007). Subsea Massive Sulphide Mining - Technology Test Program. Denver, CO: SME.

²⁴ Jackson, E., & Hunter, J. (2007). Subsea Massive Sulphide Mining - Technology Test Program. Denver, CO: SME.

²⁵ Birney et al. (2007). Potential Deep-Sea Mining of Seafloor Massive Sulfides: A Case Study in Papua New Guinea. Santa Barbara: Donald Bren School of Environmental Science & Management.

required power for the ROV to crawl over the seabed and may have a negative impact whilst driving over soft sediments (ROV may get stuck).

The fact that the ROV is electrically driven means that a significant power source is required to run the operation; this is especially the case if multiple excavators are being used simultaneously.

The ability to avoid the formation of ultra-fine particles during the rock cutting.

This is both an environmental as well as a technical requirement. The formation of plumes should be avoided to minimize the environmental impact to sea-life surrounding the operation. The technical issue with ultra-fine particles lies in the processing of the ore. These processes fail to efficiently separate ore from gangue once the particle size becomes too small (<10-15 microns) resulting in the devaluation of the ore.

Technology readiness level

The technology concept of the cutter-drum is formulated and is based on terrestrial coal mining. An experiment was conducted with a land based cutter head mounted on an ROV at 1600m depth. However, this experiment did not consider collecting the excavated material and revealed several technical issues that need to be solved mainly with the effective cutting of the rock and removal of excavated material from the rock face. There is no record of further conducted experiments; hence the technological readiness remains at TRL-2.

Technological Readiness Level

TRL - 1	TRL - 2	TRL - 3	TRL - 4	TRL - 5	TRL - 6	TRL - 7	TRL - 8	TRL - 9
---------	---------	---------	---------	---------	---------	---------	---------	---------

TRL 2 - technology concept formulated (TRL 3 - experimental proof of concept).

5.3.2 Rotating cutter head ROV – seafloor massive sulphides

Figure A.4.5.2 Rotating cutter head ROV (left) and cutter suction dredger cutter head (right)

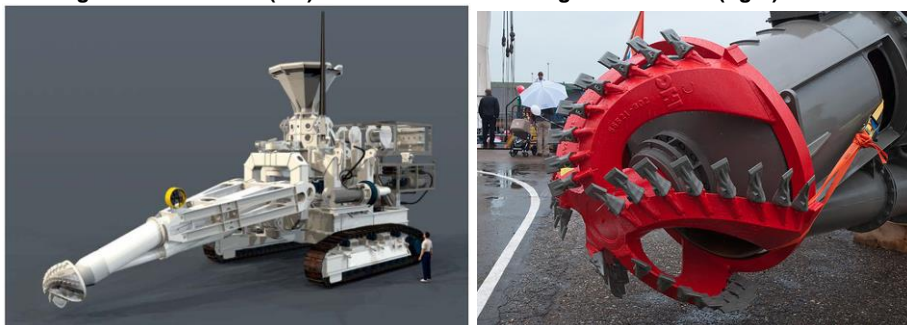

The concept of this type excavation machine is based on the equipment that was originally designed for ocean diamond mining operations off the coast of Namibia (De Beers Marine) in water depths of up to 140m.

The cutter head is mounted on a flexible drill string and its design is comparable to the cutter head used on cutter suction dredgers in alluvial dredging/mining. The cutter head design draws the crushed ore towards the centre of the cutter where the lift hose opening is located.

The rotating cutter head is more flexible to navigate compared to the drum-cutter. This would allow the ROV to work on more rugged terrain compared to the drum-cutter ROV and allows to more

selectively mine ore. The rotating cutter head ROV can also be used as a collector ROV that is following the drum cutter ROV.

Company – Overview

SMD (Soil Machine Dynamics – UK);
 Nautilus Minerals (operator – Canada);
 De Beers Group (operator - UK);
 IHC Merwede (The Netherlands);
 Perry Slingsby Systems (ROV manufacturer - UK);
 Voest Alpine (cutter/roadheader manufacturer – Austria).

The success of this excavation method is comparable to the success of the drum-cutter ROV in that the ROV should be able to deliver the required cutting force to crush the polymetallic sulphide rock. However, where the drum-cutter has only been successfully used on a production scale in dry terrestrial coal mining, the rotating cutter head is already applied today in wet dredging operations (cutter suction dredger) that provide a valuable source of performance data.

Birney²⁶ also notes that the cutter head design may reduce pluming because the rotating cutter heads draw the ore towards a central point where the inlet towards the lift hose is located. If confirmed, this method would greatly reduce the environmental impact of deep-sea mining.

Technology readiness level

Although cutter heads are successfully applied today on cutter suction dredgers there is no record of any experiments to test the behaviour of such cutter-heads to cut seafloor massive sulphides deposits and the behaviour at significant ocean depths. At the same time, ocean crawlers with cutter suction heads are used today for marine diamond mining in shelf environments (upto 150m depth). It can be concluded that there is some experimental proof for the concept but it should be further investigated to validate the applicability of the technique in a deep-sea environment to move to TRL-3.

Technological Readiness Level

TRL -	TRL -	TRL -	TRL -	TRL -	TRL -	TRL -	TRL -	TRL -
1	2	3	4	5	6	7	8	9

TRL 2 - technology concept formulated (TRL 3 - experimental proof of concept)

²⁶ Birney et al. (2007). Potential Deep-Sea Mining of Seafloor Massive Sulfides: A Case Study in Papua New Guinea. Santa Barbara: Donald Bren School of Environmental Science & Management.

5.4 ROV Clamshell grab (+ seabed rock crusher or skip hoist system)- seafloor massive sulphides

Figure A.4.5.3 Clamshell grab



Proposed by Neptune Minerals Plc this ore recovery system consists of a ROV clamshell grab that will remove the sulphide chimneys and top layer of the SMS deposit²⁷. Therefore, it is not used to excavate material, but to remove loose material on top of the seafloor massive sulphides deposit. An A-frame on the production vessel will deploy the clamshell grab and thrusters installed on the grab allow lateral movement over the seafloor. The ROV will work together with a seabed rock-crusher that downsizes the ore between 25 – 50mm before transporting it to the vertical riser system. Because the ore is directly dumped into a seabed rock-crusher, the process is more efficient compared to existing applications of the clamshell grab in which the grab is pulled up to the support vessel to be discharged. The ability of the ROV clamshell grab to move laterally should further increase efficiency as the support vessel can remain in the same position for extended periods of time.

An alternative to the seabed rock crusher may be the use of a discontinuous skip hoist system for which the skips can be filled with ore lumps that can subsequently be lifted to surface. The benefit of such a system is that the irregular size and shape of the ore is of less concern as long as it fits into the skip.

It is believed that by removing the top layer of the seafloor massive sulphides deposit first, prior to deploying a seabed mining system, sediment plumes are minimized. Furthermore, continuous suction on the rock crusher will minimize plume formation as a result of crushing activities.

ROV-guided clamshell grabs do exist today and are being used for dredging activities. Current bucket capacity varies between 10 and 16 m³ and must be adapted before they can be applied in deep-sea mining activities. This means that the bucket and teeth may need to be redesigned in order to better penetrate the seafloor massive sulphides deposit and the A-frame needs to be upgraded to deal with the increased working load as a result of the increased rope length, ore inside the bucket and any other increased weight and/or associated dynamics.

Company – Overview

Neptune Minerals Plc (Operator – US);
IHC Merwede (The Netherlands).

²⁷ Feenan, J. (2009). Seafloor Massive Sulphide Mining Concept. Offshore Technology Conference (pp. 1-11). Houston: Offshore Technology Conference.

The applicability of the clamshell grab will depend on the deposit shape and size as well as the practicality of the seabed rock crusher or skip hoist system. A significant amount of loose material must be present in order for it to be worthy to deploy a clamshell grab as the grab cannot excavate material. Due to the depth below sea level of deep-sea mineral deposits it is impractical to transport single bucket loads to surface. The clamshell grab can therefore only be successfully deployed if a seabed collector is available. A rock crusher to handle the irregular ore sizes would in that case be required if the ore is to be transported through a vertical riser system. An alternative would be the use of a skip batch hoisting system for which the individual particle size may be less important.

Technology readiness level

Although clamshell grabs are already deployed successfully today, the applicability of the grab in deep sea mining environments remains uncertain to date. Current applications of the clamshell grab are mainly in soft soils and gravel and the efficiency for rock collection should be investigated. Although the operating depth of the system is said to be only depending on rope length, transporting individual bucket loads to surface is not economic. Hence rock crusher or skip hoist system is an integral part of this technique and their conceptual stage make that this technique is overall conceptual.

Technological Readiness Level

TRL -	TRL -	TRL -	TRL -	TRL -	TRL -	TRL -	TRL -	TRL -
1	2	3	4	5	6	7	8	9

TRL 2 - technology concept formulated.

5.5 Polymetallic Nodules

Polymetallic nodules are usually distributed on the seabed at depths of 4000 to 6000 metres²⁸. Because the polymetallic nodules are not locked into a matrix, there is no need to break the rock during excavation. The excavation equipment is therefore often referred to as collectors. Two main types of collectors have been proposed over the last decades; namely passive and active collectors. This section will introduce the both systems and sub-systems.

²⁸ ISA, 2010

5.5.1 Passive Collectors - Nodules

Figure A.4.5.4 Example passive collector - 'Hybrid passive rake'

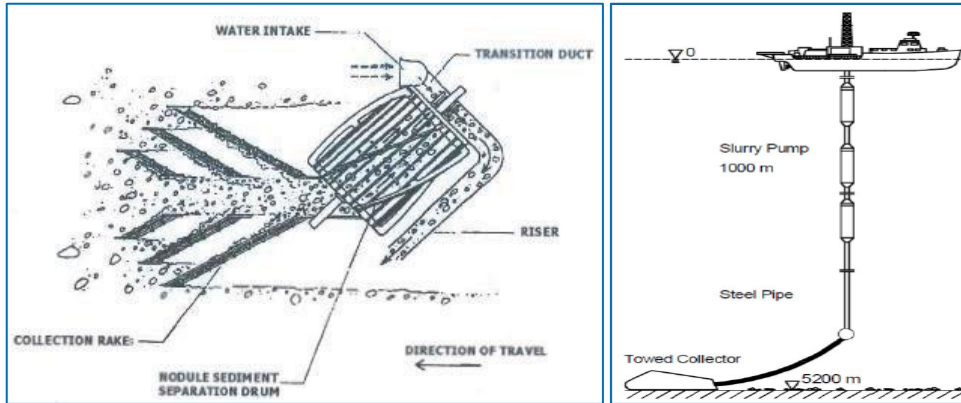

Source: Brockett, T. (1999). 'Nodule collector subsystem'. Workshop on Proposed Technologies for Deep Seabed Mining of Polymetallic Nodules (pp. 67-93). International Seabed Authority.

Most passive collectors fulfil two functions; gathering and concentrating. The passive collector is being towed along the seabed and gathers nodules and sediments. The material is forced into an inlet and both nodules and sediment are transported vertically to the support vessel.

The positives of using passive collectors are its simple design and the fact that no additional power is required to operate. The advantages over active collectors are thus low cost and simplicity. The disadvantages of passive methods include the lack of control in quantity and quality of nodules and sediment collected, huge sediment plumes on the seafloor and a relatively large amount of sediment entering the riser system²⁹. There is no sophisticated mechanism to separate the nodules from the sediment and passive collectors have a tendency to only accept nodules of a certain size range and leave oversized nodules on the seafloor³⁰. It is therefore a merely abandoned method by the industry.

Company – Overview

None. Abandoned method.

Technology readiness level

This method was tested in an operating environment and proved unsuccessful. Implementation of passive collectors is highly unlikely due to their inefficiency and lack of control. Technical limitations together with the environmental impact of the method (very large sediment plumes) make it unlikely for the method to be successfully applied on a commercial scale.

Technological Readiness Level

TRL - TRL - TRL - TRL - **TRL -** TRL - TRL - TRL - TRL -
 1 2 3 4 5 6 7 8 9

TRL 5 - technology validated in relevant environment (industrially relevant environment in the case of key enabling technologies)- though not considered as appropriate option anymore.

²⁹ Brockett, T. (1999). 'Nodule collector subsystem'. Workshop on Proposed Technologies for Deep Seabed Mining of Polymetallic Nodules (pp. 67-93). International Seabed Authority.

³⁰ Agarwal et al. (2012). Feasibility Study on Manganese Nodules Recovery in the Clarion-Clipperton Zone. Southampton: The Print Centre, University of Southampton.

5.5.2 Active Collectors - Nodules

Active collectors require an extra power source to perform nodule collection and pre-processing functions. Both mechanical and hydraulic systems exist as well as a combination of mechanical and hydraulic systems (hybrid). The active collector systems are more complex compared to the passive collectors but are able to satisfactorily separate the nodules from the sediments before vertical transportation takes place. Another advantage of the active collectors is that the possibility exists to implement a crushing system to allow for the handling of oversized nodules.

5.5.3 Mechanical systems

Mechanical systems consist of moving parts only to collect, process and transport nodules into the riser system. Figure A.4.5.5 shows an example active mechanical system that was introduced by Schwarz³¹. The system consists of a moving comb mechanism that cuts layers off of the seabed. A vibrating mechanism installed at the base of the comb is used to mechanically separate the nodules from sediments. Only the nodules are transported onto a conveyor belt that feeds into an integrated crusher before entering the vertical transport system.

Due to the great number of moving parts in the collector system, the risk of mechanical breakdown is high and the systems are therefore considered less reliable than hydraulic systems that have less moving parts that can break down. Also, the power consumption of an active mechanical system is higher than a hydraulic system³².

Figure A.4.5.5 Example active mechanical collector system.

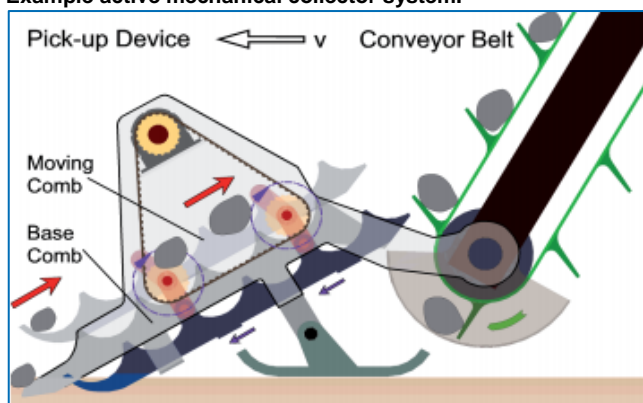

5.5.4 Hydraulic systems

Considered the most popular system to collect nodules as it is more robust and reliable than mechanical systems due to the limited number of moving parts and overall less complicated nature of the system³³. The hydraulic system minimizes the interaction between the collector and the seabed whilst extracting nodules therefore reducing the environmental impact. Mechanical systems use moving parts to separate a layer of nodules and sediments from the seafloor whereas the hydraulic system uses spray nozzles (moving seawater) for the same process³⁴.

³¹ Schwarz, I. W. (1999). Deep sea mining - lift subsystem. Workshop on Proposed Technologies for Deep Seabed Mining.

³² Brockett, T. (1999). 'Nodule collector subsystem'. Workshop on Proposed Technologies for Deep Seabed Mining of Polymetallic Nodules (pp. 67-93). International Seabed Authority.

³³ Agarwal et al, (2012).

³⁴ Brockett, 1999).

An example hydraulic collector system is presented in Figure A.4.5.6³⁵. Compared to the mechanical collector systems, this system does not cut into the seafloor whilst harvesting nodules. Aligned nozzles on the intake produce low pressure and a scouring action to lift nodules from the seabed. Subsequently a waterjet is used to separate nodules from sediment.

Figure A.4.5.6 Example hydraulic collector system

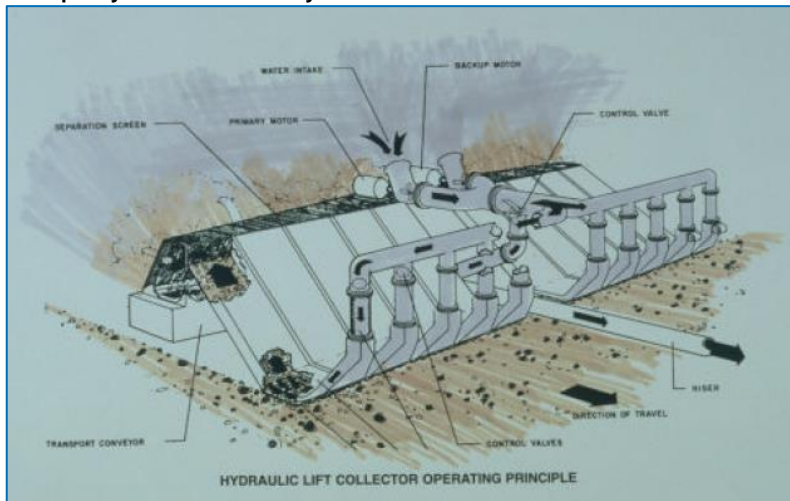

Source: Brockett et al. (2008). Updated Analysis of the Capital and Operating Costs of a Polymetallic Nodule Deep Ocean Mining System Developed in the 1970s. Polymetallic Nodule Mining Technology: Current Status and Challenges Ahead (pp. 54-81). Chennai: International Seabed Authority.

Companies – overview

Aker Wirth (Germany);

NIOT (National Institute of Ocean Technology, India).

Both mechanical and hydraulic methods are still under investigation and time should learn which one is the ultimate method. Both types of harvesting systems are being developed and tested at the moment such as the mechanical Underwater Mining System with Collector crusher (NIOT). A prototype of this excavator has been tested at a depth of 410m and it is planned to test it at a depth of 6000m.

Figure A.4.5.7 Underwater Mining System with Collector crusher (NIOT)

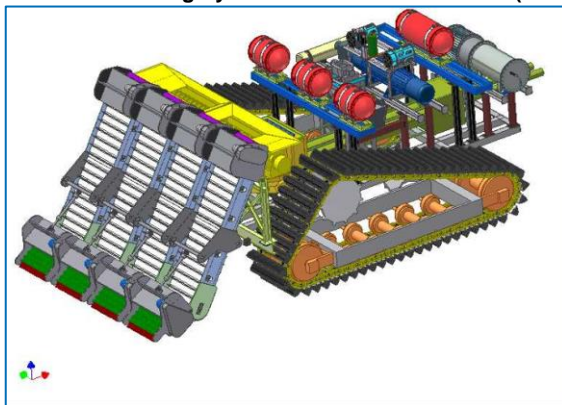

³⁵ Brockett et al. (2008). Updated Analysis of the Capital and Operating Costs of a Polymetallic Nodule Deep Ocean Mining System Developed in the 1970s. Polymetallic Nodule Mining Technology: Current Status and Challenges Ahead (pp. 54-81). Chennai: International Seabed Authority.

Agarwal et al.³⁶ note that overall the hydraulic system for nodule-sediments separation performs best. Hybrid systems (mechanical collector and hydraulic separator) are therefore also being considered as they combine the mechanical collection system with the effective hydraulic separation functionality.

Technology readiness level /

Both mechanical and hydraulically driven collectors are being developed at the moment. Experiments have been conducted in laboratory environments and systems like the NIOT Underwater Mining System with Collector crusher have been tested at shallow depth.

Technological Readiness Level

TRL -	TRL -	TRL -	TRL -	TRL -	TRL -	TRL -	TRL -	TRL -
1	2	3	4	5	6	7	8	9

TRL 4 - technology validated in lab.

5.6 (Cobalt-rich) Ferromanganese Crusts

Ferromanganese Crusts are found at depths between 400 and 4000m below sea-level. The crusts that are found at shallower depths have a higher mineral content than the crusts found at larger depths. The thickness of crust can reach up to 250mm requiring yet another approach to excavation.

5.6.1 Technologies to extract crusts: limited research conducted to date

The technology that is required to mine ferromanganese crusts is more complicated than the techniques used to mine polymetallic nodules. Where polymetallic nodules are individual, relatively small units that need to be lifted and separated from the soft sediments in which they are found, the ferromanganese crusts are bonded to their substrate rock and require breaking from it³⁷. The texture of these crusts can vary from knobby to smoothed which can have consequences for potential mining methods.

The most important step in the mining of ferromanganese crusts is the separation of the actual crust from the substrate. If not successful, the average grades of the ore would greatly deplete. Due to the more difficult mining technique compared to the mining of nodules, no real equipment has been constructed to date although some methods have been suggested.

The proposed method of Fe-Mn crust recovery consists of a bottom-crawling vehicle attached to a surface mining vessel by means of a hydraulic pipe lift system and an electrical umbilical. The mining machine provides its own propulsion and travels at a speed of about 20 cm/s. The miner has articulated cutters that would allow Fe-Mn crusts to be fragmented while minimizing the amount of substrate rock collected³⁸.

Other suggestions are to use a continuous line bucket system in areas where crusts are only loosely attached to the substrate, water jet stripping of crusts, in-situ leaching and heavy-duty rollers to crush the crusts.

³⁶ Agarwal et al. (2012). Feasibility Study on Manganese Nodules Recovery in the Clarion-Clipperton Zone. Southampton: The Print Centre, University of Southampton.

³⁷ Erry, B. J. (2000). SEABED MINING: A technical review. Greenpeace. Greenpeace Research Laboratory

³⁸ Erry, B. J. (2000). SEABED MINING: A technical review. Greenpeace. Greenpeace Research Laboratory.

The likelihood of implementation of crust-mining in the near future is low. The required techniques to effectively separate crust from substrate rock are not available yet and are key to the success of crust mining. Without correct separation of the crust from the substrate on the seafloor, ore grades would greatly deplete. A difficulty with correct separation is that crust is found on uneven surfaces. Mining without dilution means that the working surface remains uneven. It is difficult to design equipment for such surfaces³⁹.

Another limitation to the development of crust-mining techniques is the nature of crust-type deposits. Known crust deposits are thin compared to for instance SMS deposits (40mm vs. 15-20m average thickness). This means that 2Mt of crust covers an average surface area of 16 square kilometres whereas the same sized SMS deposit would cover a surface area of only 200 square meters⁴⁰. This has significant implications for both economical extraction and environmental impact and makes crust mining unlikely at the current knowledge state.

Technology readiness level

No real concepts have been developed for crust mining so far, mainly because the business case is not attractive for ferromanganese crusts. The basic principle as to what the equipment should be capable to do (separate the thin ore layer from the rock substrate) has been observed but has not yet resulted in real excavation techniques. It is unlikely that this will change in the near future due to the limited thickness and hence very large mining operation surface are as well as very large environmental impact.

Technological Readiness Level								
TRL -	TRL -	TRL -	TRL -	TRL -	TRL -	TRL -	TRL -	TRL -
1	2	3	4	5	6	7	8	9

TRL 1 - basic principles observed.

5.7 Technology assessment: Pre-processing at the seafloor

Research projects on deep sea deposits have focused on the following subsequent mining steps:

1. Excavating/Cutting of the deposit and associated sediments;
2. Vertical transport of both the ore and sediments to the support vessel;
3. Separation of seafloor massive sulphides ore from associated sediments and disposal of sediments;
4. Transportation of ore to shore for further processing.

From this existing strategy it can be concluded that pre-processing of excavated material prior to vertical transportation could significantly increase the value of the mined material. Less 'waste material' in the material flow means decreased vertical transportation costs per tonne of ore. Furthermore the environmental impact of the mining operation is reduced, as less tailings will have to be disposed from the vessel, which could result in disruption of the environment at various water depths.

Some initial attempts haven been made in the mining process of polymetallic nodules. The nodules are collected from the seafloor and separated from sediments mechanically or hydraulically. This

³⁹ Nautilus, 2004

⁴⁰ Nautilus Minerals Ltd, 2004

reduces the material flow to the support vessel/platform and at the same time increases the value of the material since the average grade of the material that is shipped to shore is increased.

It can be concluded that the higher the average grade of the ore and as early in the production process, the higher the value of the mining operation and the more profit can be made. By pre-processing of the ore on the seafloor or on-board the vessel/platform prior to shipping, we can increase the average grade.

This section will introduce several ideas as to how to increase the average metal grades in the ore stream. These concepts can be subdivided into Identification, Separation, Sizing and Concentration processes and are discussed accordingly.

5.8 Identification

Pre – processing is a post-mining, pre-physical processing function and requires assessment of each mined block after cutting and before hauling. In contrast, exploration data, pre – extraction will only give indicative or modelled variability. The concept is to upgrade the material prior to hauling and prior to processing to minimise costs. This can be done with in principle same identification and sampling techniques as used in exploration, but with a different function and aim.

5.9 Sensors

The excavator ROV should be equipped with sensors, camera equipment and sonar in order to rapidly identify the material that is to be excavated. It is likely that the visibility within the mining area will be limited as a result of sediment being lifted from the seafloor, hence identification equipment such as sonar, electro magnetic tools is required. Identification of ore and waste will determine the decision to mine the area or leave the waste behind. These sensor-based observations can be improved by continuous sampling of the excavated material.

5.10 Sampling

By sampling of the excavated material it is possible to get a 'real-time' quality map of the exposed seabed (with some processing delay). The real-time data can be used as a decision tool as to mine the material or not. It may also be used to determine an appropriate excavation order or combination of several mining areas in order to obtain a certain average grade in the ore stream. Sample analysis will have to take place at the excavator because it is impossible to retrace the source of excavated material once it reaches the surface.

Alternatively, a separate auxiliary ROV could be deployed to sample large areas before mining commences. This will significantly increase the excavator availability as it is not required to stop excavating whilst the sample is analysed.

The ability of the seafloor excavator to identify ore from waste in a low visibility environment is a necessity in the success of a subsea mining operation. Continuous measurement of ore grades is common practice in terrestrial mines and is required for appropriate mine planning and scheduling. Implementing these techniques is therefore a necessity.

Companies – overview

Similar to locating and sampling companies presented in Chapter 1.

Technology readiness level

Techniques for identification in subsea environments do exist and are already being used in ocean floor exploration. As such it should be relatively easy to install these systems to identify ore zones from waste zones. In situ grade measuring tools using XRF/XRD do exist and should also be relatively easy to implement in an ROV.

Technological Readiness Level

TRL -	TRL -	TRL -	TRL -	TRL -	TRL -	TRL -	TRL -	TRL -
1	2	3	4	5	6	7	8	9

TRL 4 - technology validated in lab / TRL 5 - technology validated in relevant environment (industrially relevant environment in the case of key enabling technologies). Lower TRL compared to exploration as the techniques are not yet used in full operational environment for pre-processing purpose.

5.11 Ore/loose sediment separation

As a first processing step the ore needs to be separated from the loose sediments that may have been excavated together with the ore and sucked into the collector. Already proposed for the mining of polymetallic nodules the separation of ore and sediments can be applied in the mining process of other deep-sea deposits and already takes place at the seafloor. This reduces the dilution in the ore stream before expensive vertical transportation or shipping to shore takes place.

To remove the fine sediments from the ore stream one can think of using screens or hydro cyclones.

Separation of ore and sediments on the seabed has been tested for polymetallic nodules mining and is necessary to avoid excessive ore dilution. Besides diluting the ore, sediments transported to surface in the ore stream need to be separated and transported back to the seafloor, which increases operating expenses. Finally, too much fines in the riser system increases the risk of clogging up the riser pipe and could shut down the whole operation.

Company – overview

No concepts yet developed by companies for deep-sea mining.

Technology readiness level

Experiments with the separation of nodules and sediments at the seafloor have been conducted and proved successful.

Technological Readiness Level

TRL -	TRL -	TRL -	TRL -	TRL -	TRL -	TRL -	TRL -	TRL -
1	2	3	4	5	6	7	8	9

TRL 3 - experimental proof of concept.

5.12 Size reduction – crushing at the sea floor

With the loose sediments removed from the ore stream crushing is required before further separation of ore and waste is possible. As the valuable minerals may be present as concentrations in a matrix of 'waste' material (no value), they have to be physically separated before further upgrading of the ore stream can take place. A first step to reduce the particle size and liberate the minerals from the matrix is crushing of the rock. The resulting particles can either be pieces of mineral or pieces of matrix or a combination of the two. These particles need to be separated further.

Size reduction (crushing) can be an essential process step prior to concentration.

Company – overview

There has not been a company developing this concept yet.

Technology readiness level

No sea-floor crusher system has been developed to date, it is still conceptual.

Technological Readiness Level

TRL -	TRL -	TRL -	TRL -	TRL -	TRL -	TRL -	TRL -	TRL -
1	2	3	4	5	6	7	8	9

TRL 2 - technology concept formulated

5.13 Concentration at seafloor

All of the methods for mineral concentration mentioned below are proven techniques that are being used in terrestrial mining operations. The goal of these methods is to upgrade the ore stream before it is fed into the processing plant where the ore is grinded to liberate the minerals for subsequent flotation or leaching. In situations where such a processing plant is situated on-shore, it can be beneficial to pre-process the ore at the mine-site to increase the value of the shipped product. For instance ferromanganese crusts require pre-processing and concentrating due to the substrate rock that is heavily diluting the ore stream. However, one could also think of applying these concepts at the seafloor already, in order to diminish the material to be lifted.

Gravity concentration

The crushed particles that consist of mineral, matrix or a combination of the two can be separated by gravity concentration (e.g. hydro cyclone). Although this method has been successfully applied in terrestrial mineral processing applications it should be investigated whether it can actually be applied in a wet seafloor setting using seawater.

Magnetic concentration

Depending on the ore being mined magnetic separation may be a viable option as well (assuming that the valuable material is magnetic). However, most sulphides are non-magnetic leaving the method only applicable to ferromanganese crusts. Sulphide ores can be separated from waste material by use of high-gradient magnetic separators but this method requires high energy.

Sensor based sorting

Based on for example XRF, sensor based sorting can separate mineral rich rock from waste material in a dry environment (although the material feed is allowed to be moist) and these methods can be applied on board a platform or vessel.

Similar techniques can be applied to slurries in order to separate ore from waste for example on the seafloor. The technique is time based and analyses flow in a tube. By measuring the time it takes for sections of ore and waste to pass they can be separated into an ore flow, a waste flow and a mixture.

Figure A.4.5.8 Sensor based ore flow separation

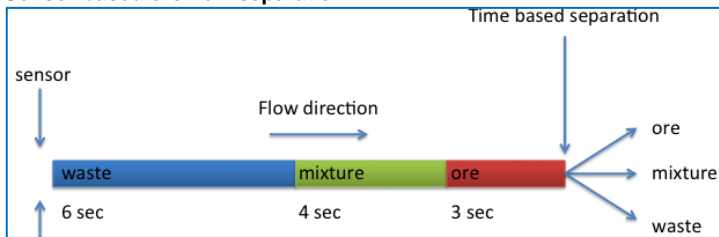

Companies – overview

There has not been a company developing this concept yet.

Technology readiness level

None of the concentration steps mentioned above have been tested in deep-sea environments. All conceptual studies to date do not consider concentration of the ore flow on the seabed.

Technological Readiness Level

TRL - 1	TRL - 2	TRL - 3	TRL - 4	TRL - 5	TRL - 6	TRL - 7	TRL - 8	TRL - 9
---------	---------	---------	---------	---------	---------	---------	---------	---------

TRL 1 - basic principles observed.

5.14 Technology assessment: Stock & Dispatch systems

After excavation, the broken ore needs to be transported to surface. In order to retain a stable and efficient flow of material in the vertical transportation system it may be necessary to temporarily stock the excavated material on the seabed. Depending on the excavation method, and if a certain particle size is required in the vertical transportation system, it may be necessary to crush the ore to a suitable size range.

Ultimately, the goal is to have a continuous flow of material whilst the vertical transportation system is running in order to keep the process as cost efficient as possible. Also, in case a more advanced processing plant is installed on board the support vessel/platform, this processing plant will require a continuous ore feed at a certain head grade to run efficiently. This can be achieved by creating multiple seafloor stockpiles of different grade that can be blended to retain a continuous flow of ore with a relatively constant head grade. Creating a large stockpile at surface seems unlikely due to the limited space available on board a production support vessel or platform.

Various technologies have been proposed and are partially similar to terrestrial mining techniques. Nautilus has proposed the use of an excavator ROV that excavates the rock and leaves it on the seabed, combined with a collector ROV that collects the broken ore and ensures a continuous

slurry flow to the vertical transportation system. Other options involve multiple excavators that feed a seabed stockpile from which the ore is subsequently transported to surface.

For relatively small-scale operations it may not be economically and/or technically viable to use continuous transportation systems like airlift or hydraulic pumps. Under such circumstances it may be beneficial to use a discontinuous batch transport technique comparable to terrestrial underground shaft-type mine operations. Buckets are filled on the seafloor and are cable-lifted to the production support vessel/platform. Advantages of this method are its simplicity and the fact that the transport system is only activated when ore needs to be transported. Furthermore, the size ranges of the ore lumps is less important compared to hydraulic or airlift systems.

As mining is expected to progress at a fluctuating rate of production, some sort of stock and dispatch system will be required on the seafloor. Either it being stockpiling before transportation via a continuous riser system or batch transportation using a skip hoist system. The other purpose of stockpiling (retaining a constant head grade) is important if an advanced processing plant is available on board the vessel/platform.

Companies – overview

There has not been a company developing this concept yet.

Technology readiness level

TRL 1 - basic principles observed (TRL 2 - technology concept formulated).

Several ideas have been proposed but a properly developed concept was not found in publicly available literature besides the concept of an excavator ROV and collector ROV by Nautilus Minerals. This is a major knowledge gap in the development of a subsea mining system.

Technological Readiness Level

TRL - 1	TRL - 2	TRL - 3	TRL - 4	TRL - 5	TRL - 6	TRL - 7	TRL - 8	TRL - 9
------------	------------	------------	------------	------------	------------	------------	------------	------------

5.15 Technology assessment: Vertical transportation

Vertical transportation of excavated ore is a critical step in the mining sequence of deep-sea mineral deposits. Vertical transport is the vertical transportation of an ore from the seabed to surface for further processing on board the production support vessel/platform. Both mechanical transportation methods (Continuous Line Bucket, Batch cable-lifting) and slurry-based methods (air lift, hydraulic pump) have been proposed to bring the ore to surface (bucket system only for nodules). The production efficiency of the vertical transportation system depends on several components such as particle concentration in the slurry, riser friction factor and/or chosen lifting system⁴¹.

5.15.1 Continuous Line Bucket system

This system consists of buckets that are connected to a continuous line. The line is being towed across the seabed whilst the buckets collect loose material. The continuous line is dragged via two ships that are connected to the ends of the line. The separation between the ships determines the

⁴¹ Agarwal et al. (2012). Feasibility Study on Manganese Nodules Recovery in the Clarion-Clipperton Zone. Southampton: The Print Centre, University of Southampton.

sweep area. A syndicate of 30 companies in Japan first tested the method in 1972. Some nodules were picked up but the method was abandoned after entanglements of the bucket line.

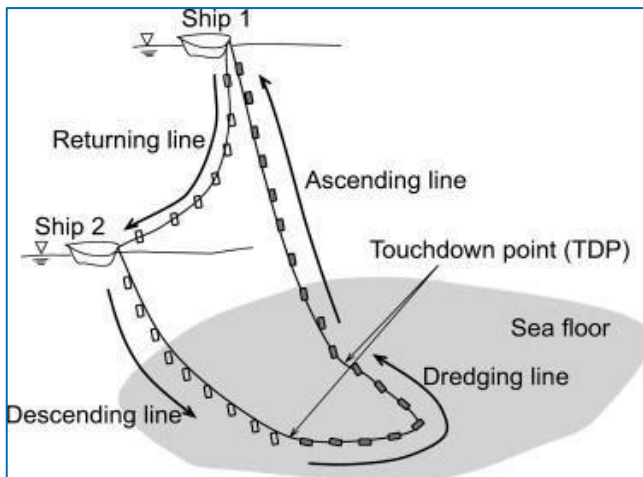

Company – Overview

None - discontinued

The main disadvantages of the continuous line bucket system are the lack of manoeuvrability, lack of production control and heavy plume formation⁴². Also the cutting power of the system is low making it impossible to ‘excavate’ material. The inefficient ore collection system together with the environmental implications of the method make that the likelihood of implementation of this method is low.

Technology readiness level

This method was tested in an operating environment and proved unsuccessful.

Technological Readiness Level

TRL - TRL - TRL - TRL - **TRL -** TRL - TRL - TRL - TRL -
 1 2 3 4 5 6 7 8 9

TRL 5 - technology validated in relevant environment (industrially relevant environment in the case of key enabling technologies).

5.16 Air Lift System

Airlift systems are three-phase flow systems based on the injection of compressed air into the riser pipe at intermediate depth. By injecting compressed air, the density of the slurry water above the injection point reduces and displaces the hydrostatic pressure equilibrium. As a result a vertical flow of water is induced towards the surface that can lift the ore to the surface production vessel^{43 44}. The technique has been used in the past on a pilot-scale to dredge polymetallic nodules from a depth of 15.000 ft (~4.500 m).

⁴² Agarwal et al. (2012). Feasibility Study on Manganese Nodules Recovery in the Clarion-Clipperton Zone. Southampton: The Print Centre, University of Southampton.

⁴³ Brockett, T. (1999). 'Nodule collector subsystem'. Workshop on Proposed Technologies for Deep Seabed Mining of Polymetallic Nodules (pp. 67-93). International Seabed Authority.

⁴⁴ Feenan, J. (2009). Seafloor Massive Sulphide Mining Concept. Offshore Technology Conference (pp. 1-11). Houston: Offshore Technology Conference.

Figure A.4.5.9 Air lift system

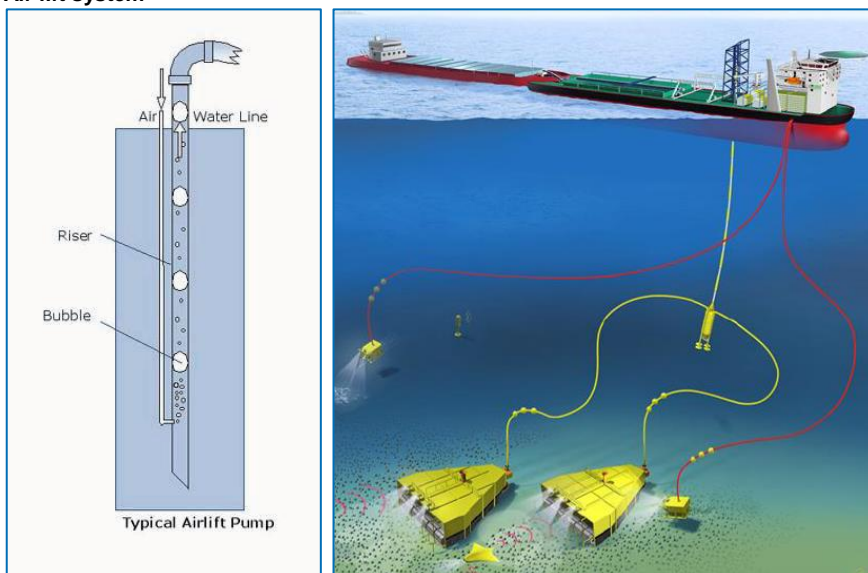

Source: Aker Solutions (2012).

Company – Overview

Aker Wirth (Germany)

The airlift system is a simple system but has several disadvantages. In order to send air down to depths of thousands of meters below sea level requires very high power. The mechanism is also very vulnerable to clogging⁴⁵. Given that a solution to the clogging problem is found, the energy requirements are likely to limit the application of the technique to shallower depths. For deposits at large ocean depths the airlift method has been largely surpassed by the hydraulic lift system. This method requires less energy.

Technology readiness level

The airlift system is a proven method to transport slurry in a vertical riser pipe. The method is applied in dredging operations within limited water depth environments. The method has been validated in transportation of nodules from an ocean depth of 15.000ft. In a pilot test but the method is now largely replaced by hydraulic pump systems in conceptual deep sea mining studies.

Technological Readiness Level

TRL - TRL - TRL - TRL - **TRL -** TRL - TRL - TRL - TRL -
 1 2 3 4 5 6 7 8 9

TRL 5 - technology validated in relevant environment (industrially relevant environment in the case of key enabling technologies).

5.16.1 Hydraulic Pump System

Hydraulic lift systems are considered simple and reliable and have a high lifting capacity. The required systems already exist as the same hydraulic pumps are currently applied in deep-ocean drilling of oil and gas wells. During these drilling operations, slurry (drill cuttings and drill-fluids) is transported to surface whereas in deep-sea mining applications it is the excavated ore that is being transported. An example existing hydraulic pump is the Hydril Pressure Control Subsea Pump by GE (Figure A.4.5.10) that is capable of transporting particles up to 50mm in diameter.

⁴⁵ Agarwal et al. (2012). Feasibility Study on Manganese Nodules Recovery in the Clarion-Clipperton Zone. Southampton: The Print Centre, University of Southampton.

Figure A.4.5.10 Hydril Pressure Control Subsea Pump.

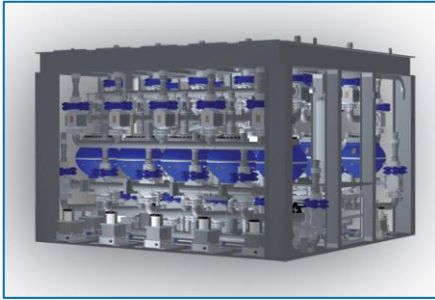

Source: General Electric, 2011.

This hydraulic pump system is part of the conceptual mining plan of Nautilus minerals in which several excavators are extracting the ore from the seafloor to provide a continuous ore flow to the hydraulic pump system and up to the production support vessel (**Figure A.4.5.12**).

A first prototype of the subsea hydraulic pump system was built and successfully tested during test drilling in the Gulf of Mexico⁴⁶ Instead of placing electrically driven pumps at the seafloor, the system was redesigned to be powered by seawater supplied from surface through a conduit to the pump located on the seafloor.

The benefit of using such a system is that all the power-generating components are located at the surface and thus, in case of failure, can be repaired without having to pull the subsea portion of the pumping system. A backup pump can be installed to allow continued production in case of maintenance or breakdowns.

Figure A.4.5.11 Typical offshore drilling riser pipe system



Source: SRK, 2010.

⁴⁶ SRK study Solwara 1, 2010

Figure A.4.5.12 Deep-sea mining concept

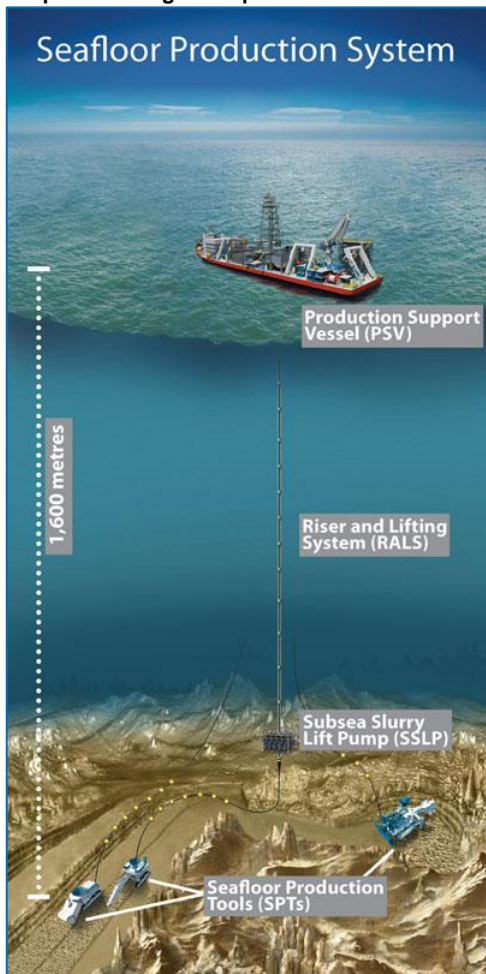

Source: Nautilus Minerals Ltd, 2014.

Company – Overview

GE Oil and Gas

GEMONOD (France)

NIOT (Research institute - India)

Nautilus (Operator – Canada)

Because the hydraulic pump system is already successfully applied in deep water oil and gas well drilling, the method seems promising for deep sea mining applications. Although the two applications for the hydraulic pump system seem similar, some differences should be investigated. Drill cuttings are more uniform in shape and size compared to ore lumps coming from deep-sea mining operations. This may result in different behaviour of the slurry in the riser pipe. Furthermore, when drilling an oil well, cuttings are only transported through the system for a limited amount of time after which only fluids (oil) will travel through the system. In deep sea mining applications the wear on the system is likely to be much higher due to the continuous transportation of sharp angled, abrasive ore particles.

Experiments and pilot tests should really indicate the direct compatibility of the system with deep-sea mining applications.

Technology readiness level

The similarity of the conceptual riser system with systems currently applied in deep-sea oil and gas drilling make this system promising for deep sea mining. The system is capable to transport rock

cuttings as slurry over large vertical distances of several kilometres and this can be seen as an experimental proof of concept. However, with the technology concept defined, the behaviour of the system should be investigated in a series of experiments and field tests.

Technological Readiness Level

TRL - TRL - **TRL -** TRL - TRL - TRL - TRL - TRL - TRL -
 1 2 3 4 5 6 7 8 9

TRL 3 - experimental proof of concept.

5.16.2 Batch cable-lifting

Siemag investigated this lifting technique for Nautilus Minerals⁴⁷. Siemag is specialized in the development of underground hoisting systems in terrestrial mining applications and has proposed a subsea lift system that can operate at a depth of up to 2000 metre below sea level. The system will hoist 100t skips and has a production rate of 400tonnes per hour.

The cable lifting system is very simple compared to the hydraulic and airlift systems that were discussed previously. The system does not require large pumps to transport the material from the seabed to surface and the batch type operation makes that it is cheaper to operate.

The overall likelihood of implementation of this system will largely depend on the size of the mining operation and the depth of the deposit below sea level. The system proposed by SIEMAG has a hoisting speed of 1.8m/s whereas in terrestrial applications speeds can be up to 10 times faster. The hoisting speed is therefore an important bottleneck for this method.

The excavation and lifting system together should be able to provide a steady supply to the processing/dewatering plant on board the production support vessel/platform. In order to achieve this it may be necessary to retain a small stockpile on-board the vessel/platform.

Company – Overview

Siemag (Germany);
 Nautilus (operator – Canada).

Technology readiness level

The technological concept for a batch-lifting system has resulted in a proposal by Siemag but no evidence of experiments or field tests was found in technical literature. The technique should however be relatively simple to apply and if one can lower/lift a heavy ROV to/from the seafloor the transportation of large skips filled with material should also be relatively simple. Experimental modelling and field tests of such a system should identify whether it can be used effectively (technical and economic) and identify potential issues with the technique.

Technological Readiness Level

TRL - **TRL -** TRL - TRL - TRL - TRL - TRL - TRL - TRL -
 1 2 3 4 5 6 7 8 9

TRL 2 - technology concept formulated.

⁴⁷ Heydon, D. (2004). Exploration for and Pre-feasibility of mining Polymetallic Sulphides - a commercial case study. ISA workshop September 2004. ISA.

5.17 Technology Assessment: Surface Operations

Once the ore is transported on to the production support vessel/platform several subsequent upgrading options are available prior to shipping of the ore:

1. Dewatering => Shipping of raw product;
2. Dewatering + Concentrating => Shipping of ore concentrate;
3. Dewatering + Concentrating + Metallurgical Processing => Shipping of final product.

5.17.1 Dewatering

Dewatering is the first and simplest method to upgrade the value of the ore. Whilst an increased value of the material being shipped is a key result of the process the main reason for dewatering is to obtain a product below the transportable moisture limit (TML). Whenever the moisture content of the ore is too high, there is a risk of liquefaction, which is very dangerous and can result in the sinking of transport vessels.

A conceptual dewatering plant for the Nautilus Solwara-1 project was described by Ausenco Minerals and included in the SRK Production System Definition and Cost Study report (2010). In the dewatering process, coarse size fractions are removed first by screening. The fine fractions are expected to meet the TML for shuttle barges (<8-9%).

Figure A.4.5.13 Dewatering Plant

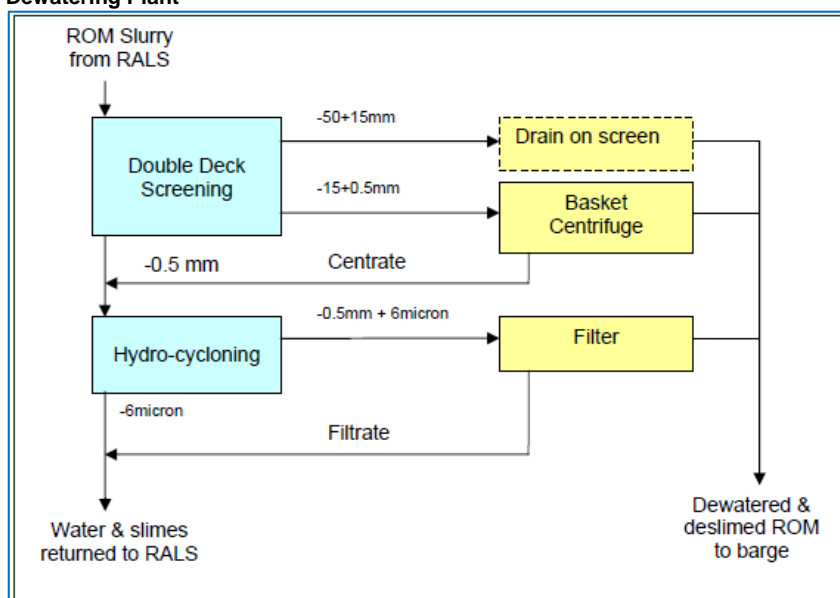

Source: Ausenco Minerals.

This is a necessary step in the mining of deep sea minerals. Without proper dewatering of the mined material it is impossible to ship it. The dewatering plant does not include any process steps to separate ore from loose sediments that may have been transported to surface together with the ore. Depending on the amount of sediments in the ROM slurry it may be worthwhile to include a ore/sediment separation step in the flow sheet prior to dewatering.

Technology readiness level

Dewatering plants are well known and to install such a plant on board a seagoing vessel or platform should not lead to any complications.

Technological Readiness Level

TRL - TRL - TRL - TRL - TRL - TRL - **TRL -** TRL - TRL -
1 2 3 4 5 6 7 8 9

TRL 7 - system prototype demonstration in operational environment.

5.17.2 Dewatering + Concentrating

Simple dewatering and subsequent shipping of the raw material on board a vessel is the primary method being considered in scoping/feasibility studies to date. Main reasons for this method are processing plant costs and environmental impact.

The development a floating concentrating plant requires large capital investments. In order to offset these investments a significant mineral reserve should be available (high revenue). Existing mineral resource knowledge is too little to justify the investment in a floating concentrating plant.

Furthermore, the environmental impact of concentrating at sea is not properly understood. The concentrating of minerals will inevitably result in tailings (waste material) that have to be disposed. Legislation on tailings disposal will determine whether concentrating at sea is a viable option.

Other reasons for not processing the ore at sea are the limited space on board a vessel and the wave-ship interaction that would prohibit the use of certain terrestrial processing methods such as froth flotation or spiral concentrators. A solution to these technical problems may be found in the offshore oil & gas industry where semi-submersible platforms have been used for decades to operate in continuously increasing water depths and provide considerably more space for processing equipment. These platforms are especially designed to remain stable and are very seaworthy making concentrating or even producing a final product prior to shipping technically a more viable option given the required electrical power for such a plant can be provided. The potential processing and mineral extraction techniques and equipment are discussed in more detail in the respective chapter of this report.

Figure A.4.5.14 Deep-water Semi-submersible and Drillship

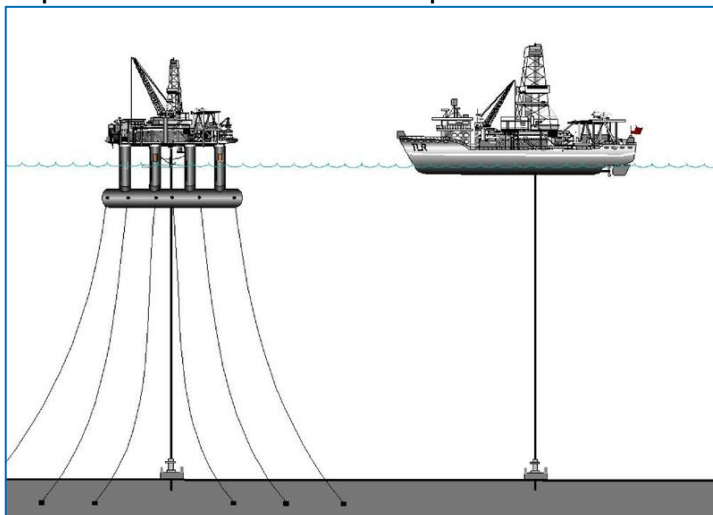

There is definitely potential in concentrating ore at sea, the main advantage being the increased value of the material that is shipped to shore. The large capital investment that is required to develop a vessel/platform based concentrating facility can only be offset if there is a large amount

of ore to be processed (large mineral reserve). Finally, impact of disposing processing tailings should be investigated in an environmental impact study.

Technology readiness level

No record of vessel/platform based concentrating was found but the concentration principles are known from terrestrial mineral processing operations and some experiments have been conducted to prove their applicability in the concentrating of deep sea ores.

Technological Readiness Level

TRL -	TRL -	TRL -	TRL -	TRL -	TRL -	TRL -	TRL -	TRL -
1	2	3	4	5	6	7	8	9

TRL 3 - experimental proof of concept.

5.17.3 Technique: Dewatering + Concentrating + Metallurgical Processing

A third option is the dewatering, concentrating and subsequent metallurgical processing of the ore at sea. However, this seems highly unlikely due to the massive space and energy requirements for such a combined concentrating and metallurgical processing facility. No attempts have been made to design such a floating metallurgical processing plant.

Due to the massive space and power requirements for a concentrating and metallurgical processing facility, this technique is highly unlikely. Furthermore, the concentrate feed of a single processing plant is unlikely to be large enough to efficiently run a metallurgical plant.

Technology readiness level

The necessary metallurgical processes have been identified but no attempt has been made to design a floating plant.

Technological Readiness Level

TRL -	TRL -	TRL -	TRL -	TRL -	TRL -	TRL -	TRL -	TRL -
1	2	3	4	5	6	7	8	9

TRL 1 - basic principles observed.

5.18 Technology assessment: Support vessel

5.18.1 Production support vessel

The Production Support Vessel (PSV) is at the centre of a deep sea mining operation, supporting the surface and subsea mining operations. The PSV is not a value chain activity as such, but it supports several phases and activities of the value chain. Operationally, the PSV is similar to many of the vessels used for deep-sea oil and gas drilling, dredging, or transportation industries. Its purpose is to supply a large deck space and a stable platform from which the mining operations are controlled, including the seafloor mining tool(s), the lifting, on board pre-processing and the transfer of the ore from the PSV to the transportation vessel⁴⁸. The extraction, lifting and surface operation processes including pre-processing activities are described in previous sections. The transportation activity will be described in one of the following sections.

⁴⁸ Grid Arendal. Deep Sea Minerals - Vol 2 - Manganese Nodules - page 48.

Although in the past some test vessels for manganese nodules mining have been developed, as the mining of manganese nodules (polymetallic nodules) and cobalt-rich crusts is not yet technologically feasible⁴⁹, for these ores it not possible to describe the techniques that are currently being used. The vessel itself, however, will probably not be that much different, as only the on-board techniques might be different. Construction a PSV is not a challenge as extensive experience from other industries is available.

Figure A.4.5.15 Production Support Vessel



Source: Nautilus Minerals. <http://www.nautilusminerals.com/s/resourceextraction.asp#PSV>.

Company – overview

Nautilus Minerals Inc. planned to extract seafloor massive sulphides within the Exclusive Economic Zone of Papua New Guinea and was developing a Seafloor Production System (SPS). However, in November 2012 it was decided to terminate this development as a result of a dispute with Papua New Guinea's government⁵⁰. In the original plan, Nautilus Minerals started developing a PSV including dewatering facilities. An image of such a vessel is displayed above.

The below list is a non-exhaustive overview of European off-shore shipyards, which are the companies most likely to be capable of manufacturing such vessel:

- IHC Merwede (NL);
- Damen (NL);
- Wagenborg (NL);
- Bodewes (NL);
- Flensburger Schiffbau-Gesellschaft mbH & Co. (DE);
- DCNS (FR);
- STX France (FR);
- Arno Dunkerque (FR);
- Lisnave (PT);
- ENVC Shipyard (PT).

⁴⁹ Allsopp et. al. (2013) 'Review of the Current State of Development and the Potential for Environmental Impacts of Seabed Mining Operations'. Greenpeace Research Laboratories Technical Report (Review). 50pp.

⁵⁰ Nautilus Minerals (2014). <http://www.nautilusminerals.com/s/Projects-Solwara.asp>. Page visited: 10-03-2014.

Technology readiness level

The development by Nautilus Minerals of a seafloor massive sulphides PSV is currently on hold. However, as the ship itself is not specifically revolutionary, we can assume that relatively few problems can be expected with the reliability and the quality of such a vessel. Still, a fully operational vessel has not yet been developed and operated in practice.

Technological Readiness Level

TRL -	TRL -	TRL -	TRL -	TRL -	TRL -	TRL -	TRL -	TRL -
1	2	3	4	5	6	7	8	9

TRL 6 - technology demonstrated in relevant environment (industrially relevant environment in the case of key enabling technologies).

5.18.2 Platform

Although the name 'production support vessel' suggests that production should always be supported by a vessel, a platform similar to an oil platform could also be an option. Depending on the circumstances, the platform may be fixed to the ocean floor, may consist of an artificial island, or may float.

Company – overview

As far as we know, no company is developing a platform specially for deep-sea mining.

Technology readiness level

As with the Production Support Vessels, Production Support Platforms (PSP) will not be very different from platforms as being used in other industries. It is the techniques on-board for the deep-sea mining activities that are different. So although, as far as we know, no deep-sea mining PSP has been developed so far, the technology to manufacture such a platform is available.

Technological Readiness Level

TRL -	TRL -	TRL -	TRL -	TRL -	TRL -	TRL -	TRL -	TRL -
1	2	3	4	5	6	7	8	9

TRL 6 - technology demonstrated in relevant environment (industrially relevant environment in the case of key enabling technologies).

6 Offshore and onshore logistics

6.1 Introduction into transportation, handling and storage

This part of the value chain entails the logistics between the offshore surface platform or vessel and land-based destinations where final processing takes place. The graph below indicates the main elements of the value chain.

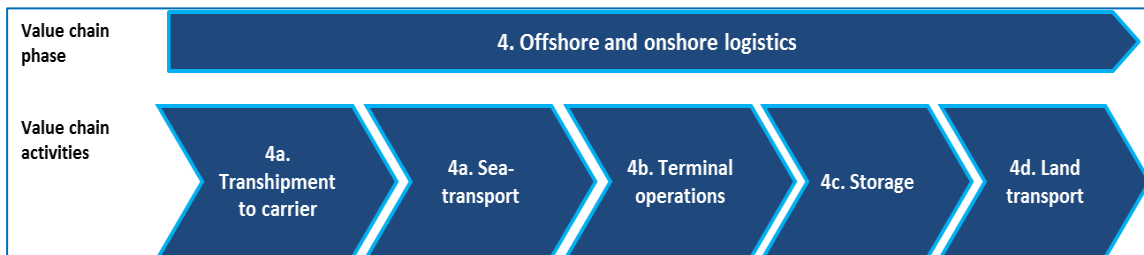

6.2 Technology assessment Transhipment from platform to ore carrier

There is wide experience in ship-to-ship transhipment of bulk cargoes, notably for the lightering of large bulk carriers using barges close to ports of destination. The main reasons then are shallow water/port access limitations for large draught ships.

However such operations usually take place near ports in safe or protected sea areas where weather and nautical conditions are reasonable. There is no experience in using these technologies in the open ocean.

TRL 9 (near shore) / TRL 5 (deep-sea).

6.3 Technology assessment: Sea-transport

The trans-ocean shipping of ores is widely applied and also the construction of ore carriers is well-developed. It is assumed that the specific composition of deep-sea mined ores, which may differ from land-originating ores does not affect the ship specifications or navigation conditions.

TRL 9 - actual system proven in operational environment (competitive manufacturing in the case of key enabling technologies; or in space)

6.4 Technology assessment: Terminal-operations

As for sea-transport of ores, the unloading in seaports is also well-developed and a variety of systems exists, all proven and in use for many years.

(PM elaborate).

TRL 9 - actual system proven in operational environment (competitive manufacturing in the case of key enabling technologies; or in space).

6.5 Technology assessment: Storage

Storage of ores in ports or elsewhere is being done for many years already. The level of sophistication required varies with local regulations (e.g. air dust from ore particles near residential areas, requiring f.i. coverage or watering of the ore storage) and possibly the ore composition (e.g. oxidation). Whether such requirements will differ for sea-originating ores is unknown.

TRL 9 - actual system proven in operational environment (competitive manufacturing in the case of key enabling technologies; or in space)

6.6 Technology assessment: Land transport

The transport of ores on land is usually done by train or barge as for e.g. iron ores it concerns high volume low value/low time-critical cargoes. For higher value sea-bed ores this might differ and truck transport might be used. All modes have sophisticated transportation means available.

TRL 9 - actual system proven in operational environment (competitive manufacturing in the case of key enabling technologies; or in space)

7 Processing techniques

7.1 Introduction into Processing

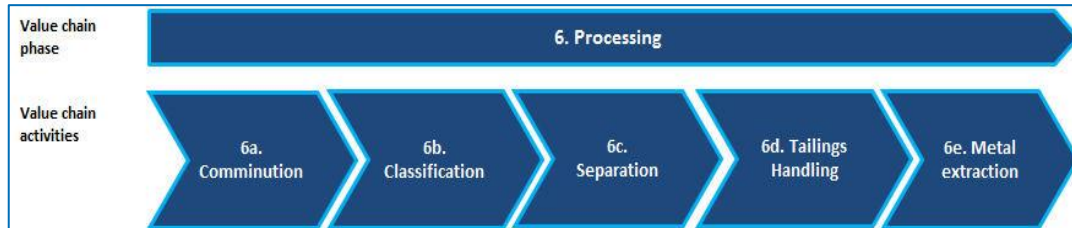

7.1.1 Metals extractable from deep sea ore

1. Polymetallic Nodules:

Manganese, nickel, copper, and cobalt can be extracted from **polymetallic nodules**.

2. Cobalt-rich crusts:

These are also termed **cobalt-rich ferromanganese crusts**, and are found on the flanks and summits of seamounts, ridges and plateaux, throughout the world's oceans, where seafloor currents have swept the ocean floor clear of sediment for millions of years. The crusts do not occur at places where sediment is present on the ocean floor. Cobalt-rich crusts are obviously a new source for *Cobalt (Co)*. According to Hein et al. 2010⁵¹, ferromanganese crusts are likely to contain also: *Tellurium (Te)*, *Bismuth (Bi)*, *Zirconium (Zr)*, *Niobium (Nb)*, *Tungsten (W)*, *Molybdenum (Mo)*, *Platinum (Pt)*, *Gold (Au)*, *Titanium (Ti)*, *Thorium (Th)*; Platinum group elements (*PGE*, being *Platinum (Pt)*, *Rhodium (Rh)*, *Ruthenium (Ru)*, *Iridium (Ir)*, *Osmium (Os)*, and *Palladium (Pd)*) and also *gold (Au)* are of significance in the Co-rich ferromanganese crust of the Afanasiy–Nikitin Seamount in the Indo- Australian Basin⁵².

3. Polymetallic Sulphide Deposits

Also the terms *Volcanogenic Massive Sulphide deposits* and *seafloor massive sulphide deposits* are applied. VMS is usually applied for such deposits found on land. These ores mainly contain *Iron (Fe)*, *Copper (Cu)* and *Zinc (Zn)*, but also *Lead (Pb)*, *Arsenic (As)*, *Antimony (Sb)*, *Gold (Au)*, and *Silver (Ag)* are encountered⁵³). Please see the geological analyses for the known locations of the SMS deposits.

With respect to currently available information the sizes, of seafloor massive sulphides deposits are generally much smaller than their counterparts on land. Many of these land based deposits were formed in comparable, but much more ancient submarine environments. The size of a typical large onshore deposit is 50 – 60 Mt, whereas on the seafloor, most deposits are of the

⁵¹ Hein, J.R., Conrad, T.A., Staudigel, H. (2010) Seamount Mineral Deposits. A Source for Rare Metals for High-Technology Industries. *Oceanography*, 23, No. 1, 184–189.

⁵² Banakar, V.K., Hein, J.R., Rajani, R.P. Chodankar, A.R. (2007) Platinum group elements and gold in ferromanganese crusts from Afanasiy–Nikitin seamount, equatorial Indian Ocean: Sources and Fractionation. *Journal of Earth System Science*, 116, No. 1, February 2007, pp. 3–13.

⁵³ Hoagland, P., Beaulieu, S., Tivey, M.A., Eggert, R.G., German, C., Glowka, L., Lin, J. (2010). Deep-sea mining of seafloor massive sulphides. *Marine Policy*, 34, 728–732; Herzog and Hannington, 1995,

size of 1 – 5Mt. The metalliferous muds of the Atlantis II Deep in the Red Sea (90 Mt) may be the only seafloor massive sulphides deposit similar in scale to the large onshore deposits⁵⁴.

7.1.2 Mineral Processing

Mineral Processing involves all the work from:

- resizing the ore from the mined pieces to manageable sizes for further processing;
- to classification in size categories;
- to mineral separation;
- to tailings handling;
- to metal extraction (some people consider this not to be mineral processing anymore – visions differ).

Mineral processing involves techniques like comminution (size reduction by breaking, milling), classification (e.g. sieving) to separation of valuable minerals from invaluable bulk. A famous overview of Mineral Processing Techniques can be found in Wills & Napier-Munn⁵⁵.

The mineral concentrates can then be used in extractive metallurgical processes to liberate the metals.

7.1.3 Ship and Platform

For efficient use of ships and equipment, use of a platform in a central place with respect to the mining locations should be envisaged. Platforms are very stable, and instability issues like on ships are not important. The technology for such platforms in deep sea is well established in the oil industry.

A central platform where most of the processing is carried out is much more efficient, than carrying-out processing on a ship. The ship transports the mined ore to the platform, and then returns to the mining site taking back rock waste to be discarded. On the platform the ore is processed, and concentrates can be shipped to on-shore locations.

7.1.4 Dry versus Wet Processing

In mineral processing most often processing is carried out on **dry materials**. For deep-sea ores this will be **wet material**. This obviously concerns seawater, which may be corrosive. This has to be taken into account in design and construction of equipment. On the other hand, seawater is conductive, which may be of influence in the processing.

7.2 Technology assessment: Comminution

For use on land this is very well known. For use on sea-going vessels, this is not known.

The limited space on a ship is certainly important for the crushing and grinding stage, as the industrial scale equipment used for these is quite large, and rather heavy. Use of a platform would

⁵⁴ Hoagland, P., Beaulieu, S., Tivey, M.A., Eggert, R.G., German, C., Glowka, L., Lin, J. (2010). Deep-sea mining of seafloor massive sulphides. *Marine Policy*, 34, 728–732.

⁵⁵ Wills, B.A., Napier-Munn, T. (2006) *Mineral Processing Technology* (7th edition), Elsevier, 444pp.

mitigate these problems. At the same time it is worth noting that the host rock for the different reserves might vary in size and the grade ores are also different.

There are several types of crushing machines that are commonly used. They are:

- Jaw crusher;
- Impact crusher;
- Cone crusher;
- Gyratory crusher;
- Roll crusher.

Considering the unknown hardness of the material, a jaw crusher may prove a better solution than an impact crusher, which is generally used for softer material. Also a jaw crusher is a mechanically simpler machine, compared to an impact crusher. This is also an advantage, with respect to maintenance. Taking into account capacity, a cone crusher may be an even better solution. A cone crusher breaks rock by squeezing the rock between an eccentrically gyrating spindle. Cone crushers are quite similar in operation to gyratory crushers. However, a cone crusher has, in comparison to a gyratory crusher, less steepness in the crushing chamber and more of a parallel zone between crushing zones.

A fourth type of crusher is the roll crusher. Roll crushers, however, are less productive with respect to volume, and have a somewhat higher maintenance compared to a gyratory crusher or a cone crusher.

Of further importance is whether the crusher can handle wet material. Considering that material from deep-sea-mining will be wet, a cone crusher is probably the best solution, as this type of crusher can handle wet material. The material should, however, preferably not be sticky. In general, cone crushers are known to be “self-cleaning”, but with respect to this, testing with deep-sea ore samples should be carried out.

Figure A.4.7.1 Jaw Crusher

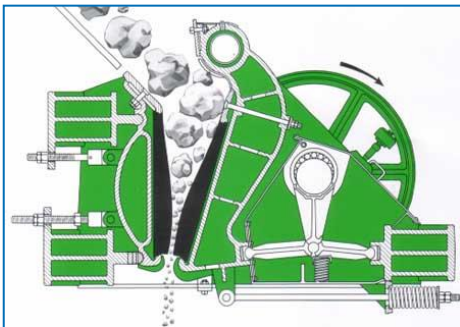

Source: Pennsylvania Crusher.

Figure A.4.7.2 Impact Crusher

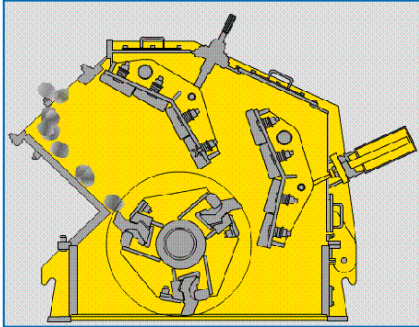

Source: <http://www.hotcrusher.com/products/crushing/pfw-impact-crusher.html>.

Figure A.4.7.3 Cone Crusher

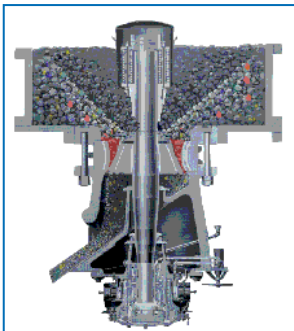

Source: http://www.mine-engineer.com/mining/cone_crusher.htm.

Figure A.4.7.4 Gyratory crusher

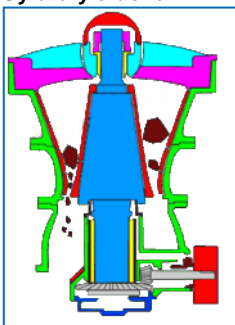

Source: solidswiki.com.

Figure A.4.7.5 Roll crusher



Source: <http://www.mine-engineer.com/mining/rollcrush.htm>.

For further size reduction, the milling process is used. First stage grinding reduces the size of materials from 50 mm to 300 μ m. Second stage grinding reduces them from 300 μ m to the required size. Several types of equipment are usually applied here: rod mills, ball mills and semi-autogenous mills (SAG-mills). In the first, hard steel rods are used as the grinding medium. Such mills are usually applied for coarse grinding.

Rod mills are to be considered as fine crushers, or coarse grinding mills, and are used in the first grinding stage. Feed can be up to 50 mm, and they can make a product as fine as 300µm. Because of the typical grinding action of rods, which will preferentially grind the larger particles; the product has a relatively narrow size range. They are nearly always run in open circuit. They have however a severe disadvantage: when the rods wear down gradually during time, at a certain point the rods may break. To remove the broken rods, the rod mill must be shut down. For ball mills and SAG mills in case of a damaged ball this is not the case.

An alternative is the use of Autogenous (AG) or Semi-autogenous (SAG) mills. In the SAG-mills, attrition between grinding balls and ore particles causes grinding of finer particles. SAG-mills are characterized by their large diameter and short length as compared to ball mills. In ore processing, a SAG-mill is often used as a first stage grinding solution, replacing rod mills.

For second stage grinding, ball mills are applied. First stage grinding reduces the size of materials from 50 mm to 300µm. Second stage grinding reduces them from 300µm to the required size.

Ball mills are thus used for the fine finishing, as they have a greater surface area per unit weight than rods. They are usually operated in a closed grinding circuit (see figure). Only material that is fine enough, leaves the grinding circuit, preventing overgrinding.

Figure A.4.7.6 Simple closed-grinding circuit

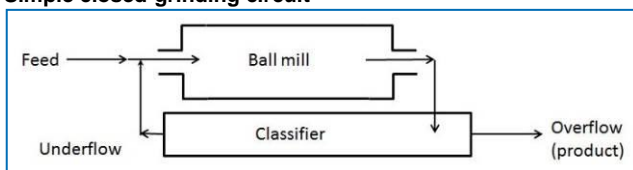

Source: after Wills, 1997.

But also here, one must consider that the material will be wet. Regarding this, SAG-mills would again be a good choice, as they can handle wet material as well. One thing to test is the optimum amount of water in the slurry that is fed into the mill.

Figure A.4.7.7 Rod Mill

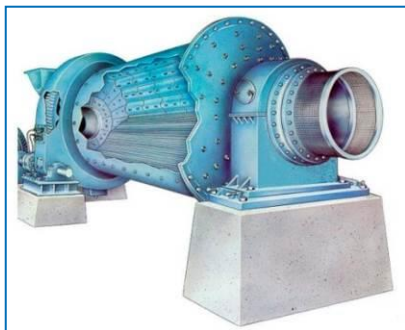

Source: www.directindustry.com.

Figure A.4.7.8 Ball Mill



Source: www.limingmachinery.com.

Figure A.4.7.9 A SAG-Mill



Source: <http://www.flsmidth.com>.

Comminution is the first step in the liberation of valuable minerals from their host rock (the ore) and is therefore a necessary activity within the value chain. Both technical and environmental challenges lie ahead and will determine the practicality of comminution to take place at sea or on shore.

Company – overview

A list of European Mining Grinding Mills Suppliers per country is obtained from an industry organisation⁵⁶:

UK

Falcon Concentrators (was Sepro Mineral Systems);
Tenoa Delkor;
Bradken Resources Pty Limited;
Bridge Abrasives Ltd.;
Christy Turner Ltd;
Helipebs Controls Limited;
Kubota Corporation;
F.J. Brindley & Sons (Sheffield) Ltd;
International Innovative Technologies (IIT) Ltd;
Atritor Ltd.

Germany

Sepro Mineral Systems is now home to Falcon Concentrators;
L & N Grinding Systems;
Litzkuhn & Niederwipper GmbH;

⁵⁶ Infomine, <http://www.infomine.com>.

Teknikum Oy;
Koppers Equipment Inc.

Turkey
Sepro Mineral Systems is now home to Falcon Concentrators;
MIS Mak. Ins. San. Ltd. Sti.

France
Ferry-Capitain.

Ireland
Coles Mining Limited.

Spain
Forjas Santa Barbara S.A.

Austria
PMT-Jetmill GmbH;
Cemtec GmbH.

Belgium
Magotteaux International s.a.

Lithuania
Geola Ltd.

Sweden
Metso;
Komab Industriteknik AB;
Ståhle's Mining and Construction Ltd (SMC AB).

Finland
Metso;
Teknikum Oy.

Bulgaria
Sepro Mineral Systems is now home to Falcon Concentrators.

Norway
King Pin International.

Technology readiness level

The comminution technology is well developed for land based mining operations and has a TRL of 9. It seems logical to use the same techniques for the comminution of deep sea ores, however because most terrestrial ore is processed in a dry state, experiments should be conducted to evaluate the comminution efficiency of equipment when the feed consists of wet or moist ore.

Technological Readiness Level

TRL -	TRL -	TRL -	TRL -	TRL -	TRL -	TRL -	TRL -	TRL -
1	2	3	4	5	6	7	8	9

TRL 2 - technology concept formulated.

7.3 Technology Assessment: Classification

For use on land this is very well known. For use on sea-going vessels, this is not known. Wet screening techniques will probably not lead to difficulties, probably not even when processing fine material. When hydrocyclones are applied as classifier, already fairly fine material is needed to make the hydrocyclones work optimally. A pitfall for hydrocyclones is that smaller high-density particles will behave similar to larger low-density particles.

Figure A.4.7.10 Hydrocyclone

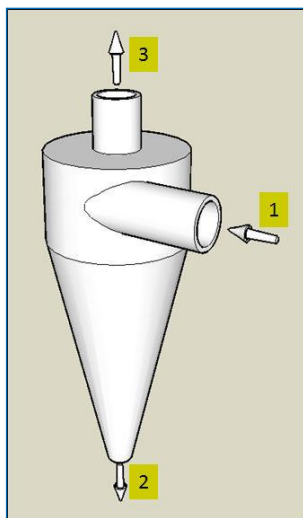

Hydrocyclone:
1. Inlet.
2. Outlet for heavy solids.
3. Outlet for light solids.

Classifiers are used in mining operations today in both dry and wet environments (e.g. alluvial, dredging operations). Classification prior to mineral separation is required to obtain the optimal particle size feed for the mineral separation stage. For example, the undersize particles can be fed into the flotation process whilst the oversized particles are fed back into the grinding mill for further comminution.

Company – overview

All Mining Suppliers, Equipment - Crushing & Conveying – Classification

FLSmidth;

Quinn Process Equipment Co.;

Centrifugal & Mechanical Industries (CMI);

ECUTECH Barcelona S.L.;

FMC Technologies, Inc.;

Haver & Boecker OHG;

LCA Detectores de Metais;

Mineral Engineering Processes Ltd.;

Minivevor Products Ltd.;

PMT-Jetmill GmbH;

Polydeck Chile S.A.;

Presanger Locação de Equipamentos Ltda;

Derrick Corporation;

Phoenix Process Equipment Co.;

Smico Manufacturing Company LLC;
 Aggregates Equipment Inc.;
 Europarts;
 G & G Industrial S.R.L.;
 Central Machine & Fabrication;
 Classification & Flotation Systems Inc.;
 Detecsul Indústria Eletrônica Ltda.;
 Eagle Iron Works;
 Eral, Equipos Y Procesos S.A.;
 Gornye Tehnologii;
 GTH, OOO;
 Loesche GmbH;
 Mactek Technologies Inc.;
 MBE Coal & Minerals Technology GmbH;
 Milticor Comércio de Correntes e Engrenagens Ltda;
 Piacentini & Cia Ltda;
 Ural-Omega, PJSC;
 Vibrosito;
 Chuangye Metal Wire Mesh Co., Ltd. O;
 DSM Osman Cubuk Ltd.Sti;
 Floatex Separations Ltd;
 Maker Machinery and Production LLDC;
 Mcl Argentina Srl.

Technology readiness level

Particle classification is a well-known process and is applied in dry and wet mining environments. Implementing classification equipment in a deep-sea mineral processing plant should therefore not result in any problems. Screening is routinely used in offshore diamond mining and hydro cyclones are likely to perform well on a seagoing vessel/platform although this has not been tested.

Technological Readiness Level

TRL -	TRL -	TRL -	TRL -	TRL -	TRL -	TRL -	TRL -	TRL -
1	2	3	4	5	6	7	8	9

TRL 7 - system prototype demonstration in operational environment.

7.4 Technology assessment: Mineral Separation

For use on land this is very well known. The movement of the ship due to wave action has especially an impact on wet techniques, making Gravity Separating Tables, Froth Flotation and Jigging seem unpractical. To counteract the motion of the ship due to wave action a stabilized platform could be envisaged, but wet, open, techniques still seem unpractical.

Gravity separating tables also take a lot of space, which is a serious disadvantage for use on a ship. The possibility of using spiral separators seems doubtful, but could be tried out experimentally.

Magnetic separation and hydro cyclones should not provide any difficulty for use on a seagoing ship. However, magnetic separation implies that at least one of the (valuable) minerals is magnetic (paramagnetic, ferrimagnetic or ferromagnetic). **Sulphides** are in general **non-magnetic**.

Figure A.4.7.11 Humphrey's spiral, schematic

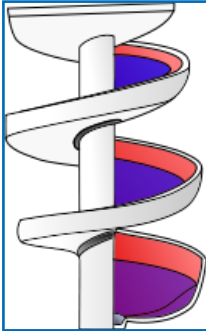

Source: wikipedia.org.

Figure A.4.7.12 Two spiral concentrators

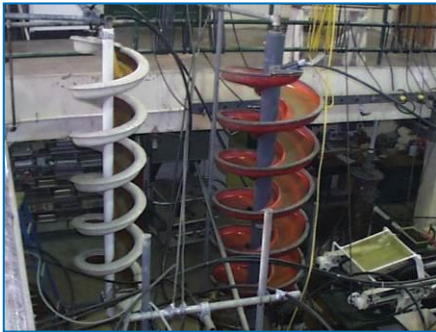

Source: University of Wyoming.

Figure A.4.7.13 Spiral concentrators

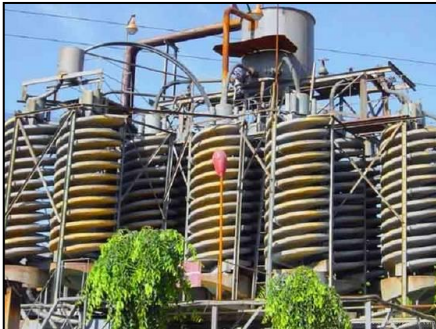

Source: Jiangxi Gandong Mining Equipment Machinery Manufacturer Factory.

Figure A.4.7.14 Gravity separation table, schematic

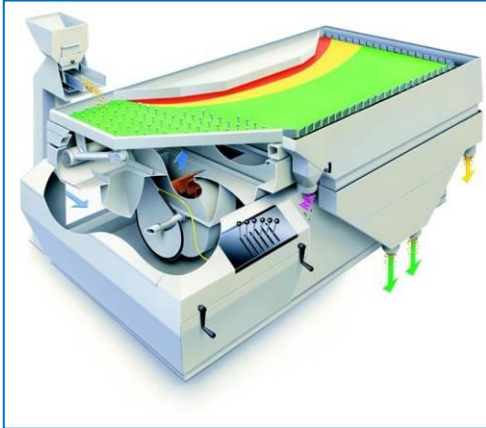

Source: E. Buttmer & Co.

Figure A.4.7.15 A set of gravity separation tables in operation



Source: Gongyi Henchang Metallurgical Building Materials.

Figure A.4.7.16 A series of hydrocyclones



Figure A.4.7.17 Schematic diagram of jigging: (1) pulsator, (2) jig bed, (3) jigging screen

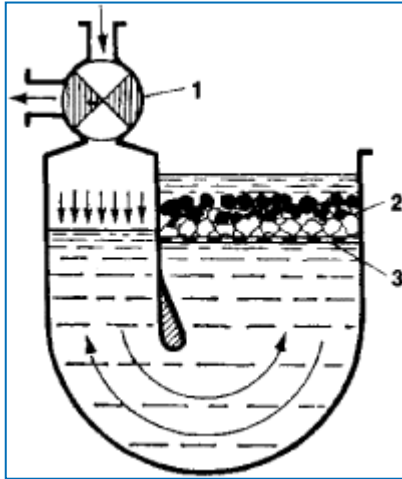

Source: <http://encyclopedia2.thefreedictionary.com/Jigging>.

Figure A.4.7.18 Example of a Jig



Source: Yufeng Heavy Machinery.

Figure A.4.7.19 Magnetic separation, schematic

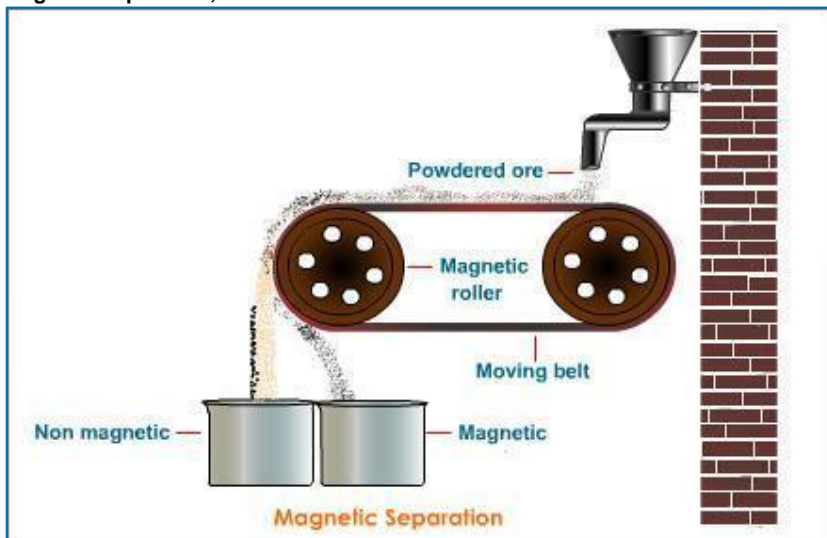

Figure A.4.7.20 Froth Flotation



Several techniques exist to separate valuable minerals from invaluable gangue and most are suitable for wet material. Experiments should be conducted in order to determine the optimal techniques for the separation of deep sea ores. The size of the individual mineral crystals is an important factor in the selection of suitable separation equipment.

Company - overview

FLSmith;
Gekke Systems Pty Ltd.;
Metso;
Tenova Delkor;
Westech Equipamentos Industriais Ltda.;
Sepro Mineral Systems is now home to Falcon Concentrators.

Technology readiness level

The mineral separation techniques are well understood and documented. Research should focus on the determination of the best (combination of) technique(s) to maximize valuable mineral recovery and maximize mineral grades in the produced concentrate. Laboratory tests have been conducted over the last decades to determine the applicability of e.g. flotation to concentrate deep-sea ores. As a next phase, small-scale pilot plants could be developed to determine separation efficiency of a 'real' plant and according flow sheet.

Technological Readiness Level

TRL - 1 TRL - 2 TRL - 3 **TRL - 4** TRL - 5 TRL - 6 TRL - 7 TRL - 8 TRL - 9

TRL 4 - technology validated in lab.

Table A.4.7.1 Separation techniques for use on sea-going vessels

Ores	Separation Techniques					
	Spirals	Shaking Tables	Hydro-cyclones	Froth Flotation	Jig	Magnetic Separation
Poly-metallic sulphides	To be investigated	Unpractical	Possible	Unpractical	To be investigated	Not possible. Sulphides are in general non-magnetic*
Poly-metallic nodules	To be investigated	Unpractical	Possible	Unpractical	To be investigated	Depending on mineral content
Cobalt-rich crusts	To be investigated	Unpractical	Possible	Unpractical	To be investigated	Depending on mineral content

* Pyrrhotite, $Fe_{1-x}S$, is the only common sulphide that, depending on its composition, **can** be magnetic. Based on expert judgement from TU Delft' processing experts

7.5 Technology assessment: Tailings Handling

Every separation technique produces tailings, which in many cases must be discarded.

The issue of discharging loose rocks waste, when no chemicals are involved, is merely damage to the underwater environment, but considering that damage is already done by the mining action, this may be considered of minor importance. For environmental reasons, flotation tailings probably cannot be discharged into the sea.

Legal issues however, are a matter of concern. When operating within the EEZ of a certain country, the laws of that specific country apply, but on the "high sea", the rules of UNCLOS (1982) apply. Compliance with these rules is checked by the ISA, and this should be taken into account in any case of deep-sea mining.

Technology readiness level

As a result of sea-based processing, tailings will be produced. A solid plan to deal with these tailings is required if sea-based processing of the ore is considered.

Technological Readiness Level

TRL - 1 TRL - 2 TRL - 3 TRL - 4 TRL - 5 TRL - 6 TRL - 7 TRL - 8 TRL - 9

TRL 1 - basic principles observed.

7.6 Technology assessment: Metal Extraction

For use on land metal extraction is very well known.

Metal extraction techniques are pyro metallurgical (with heat, temperatures up to several hundreds or even above thousand degrees Celsius), hydrometallurgical (wet chemical) or electrometallurgical (wet chemical processes with electrolytic cells).

Different mineral extraction techniques can be applied depending on the type of deep-sea mineral deposit. Depending on the deposit, concentrating of the valuable minerals prior to mineral extraction may be necessary (seafloor massive sulphides, Cobalt-rich crusts) or grinding and direct extraction may be possible (Polymetallic nodules). New extraction techniques may be required to obtain the final metals or existing terrestrial methods may be applicable directly.

Ores:	Identified Concentrating techniques		
Polymetallic sulphides	Flotation + Smelting	Magnetic Separation + Smelting	
Polymetallic nodules	Cuprion process	Sulphuric leaching	Smelting
Cobalt-rich crusts	Gravity Separation + Smelting		

7.6.1 Polymetallic Sulphides

More suitable for on-site upgrading prior to shipping by using traditional terrestrial methods such as crushing, grinding and subsequent concentration to obtain an ore that can be shipped to a smelter facility on shore. Because the chemical characteristics of Polymetallic Sulphides are similar to land-based deposits, the concentrate can be shipped to existing smelter facilities that are often easily accessible over water.

A difficulty of processing seafloor massive sulphides deposits is the fine-grained mineral size that is partly a consequence of the manner in which the sulphides are precipitated from the hydrothermal fluids. Rapid quenching of the solutions as they mix with the cold seawater results in poor nucleation of minerals and limited growth of large crystals⁵⁷. Analyses of samples from the East Pacific Rise 11oN and Southern Explorer Ridge indicate particle sizes for pyrite, sphalerite and chalcopyrite in the range of 1-600 microns with an average between 22 and 37microns. Re-crystallization of more mature deposited minerals may result in larger particle sizes.

Herzig notes that treating methods for fine-grained ores are poorly developed and in order to liberate the individual grains, a lot of energy is required. In land based mining operations, significant losses occur in the ultra-fine particle fraction of less than 10 microns. It may be that the particle size of some deposits is simply too small to be processed economically as the main processing method for small particles (flotation) has limited effect on separating ultra-fine particles.

Fine grinding followed by high inductance magnetic separation has been tested for seafloor massive sulphides deposits and resulted in a copper and zinc concentrate with a recovery of

⁵⁷ Herzig, P. (2000). Technical requirements for the exploration and mining of seafloor massive sulphides deposits and cobalt-rich ferromanganese crusts. Minerals other than polymetallic nodules of the international seabed area (pp. 303-316). Kingston: ISA.

81%⁵⁸. Grinding followed by magnetic separation could be applied on board the support vessel to upgrade the ore concentrate prior to shipping to shore.

Another challenge in the mineral extraction of seafloor massive sulphides deposits is gold recovery. Gold typically also has a uniformly small grain size (<10 microns) which results in inadequate liberation of the gold particles during mineral processing. The ultra-fine gold particles require extra fine grinding (hence increased energy costs) and this compromises the recovery of copper and zinc. This is a major challenge that needs to be solved in order to extract the true value of seafloor massive sulphides deposits.

Technology readiness level

Technological Readiness Level

TRL - 1 TRL - 2 TRL - 3 TRL - 4 TRL - 5 TRL - 6 **TRL - 7** TRL - 8 TRL - 9

TRL 7 - system prototype demonstration in operational environment.

7.6.2 Polymetallic Nodules

Whereas SMS deposits are metallic *sulphides ores*, Polymetallic Nodules are *oxides ores*. Hence, mineral extraction requires a different approach. For instance, froth flotation is not used to concentrate oxide ores because oxide minerals do not bind to the froth flotation chemicals.

The main challenge with polymetallic nodules is to effectively dissolve/reduce the manganese dioxide in order to free the economic amounts of cobalt, nickel and copper. Several extraction methods have been proposed over the last decades with some methods allowing for the extraction of manganese whilst other methods consider manganese extraction as being too difficult.

Cuprion process

In order to effectively use the cuprion process the nodules are ground to and processed as fine slurry. The particles are subsequently reduced by carbon monoxide at low temperature and in presence of ammonia in an agitated tank. Copper, nickel and cobalt are made soluble by counter current decanting in a series of thickeners. Nickel and Copper are then extracted by electrolysis and cobalt is removed by sulphide precipitation⁵⁹. All manganese is considered tailings when using this method as manganese extraction from the residue proved difficult.

⁵⁸ Alton et al. (1989). Potential for processing seafloor massive sulfides by magnetic separation. *Marine Mining*(8), 163-172.

⁵⁹ International Seabed Authority

Figure A.4.7.21 Cuprion Process Flow Sheet

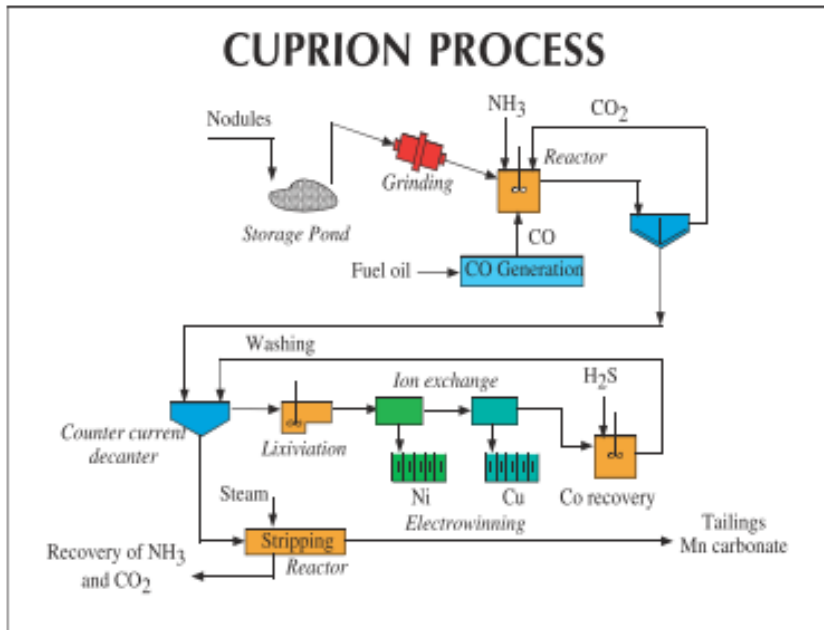

Source: International Seabed Authority, <http://www.isa.org/im/en/home>.

Sulphuric leaching

Introduced by Fuerstenau in 1973, and later improved by the French Commissariat à l'Énergie Atomique.

Nodules are crushed and sulphuric acid at 180 degree Celsius and a pressure of 1200 KPa dissolve the metals inside the particles. Bivalent manganese ions (Mn²⁺), formed by pre-reduction of some of the nodules with sulphuric gas, are introduced into an autoclave (steam-pressured heating chamber) to increase the recovery of cobalt. Copper, nickel and cobalt are precipitated from the resulting solution using hydrogen sulphide. The copper sulphide is roasted to give an oxide concentrate, while the nickel-cobalt concentrate is kept as a sulphide (ISA, polymetallic nodules).

Further refining to obtain the final metals consists of:

1. Sulphuric acid leaching and subsequent electro winning of the copper oxide concentrate;
2. Nickel-Cobalt sulphide is further refined (elimination of iron and zinc) by melting it into chlorine & water and finally separated by ion-exchange solvents. The resulting cobalt chloride is sent to a cobalt refinery and the nickel is extracted by electrolysis;
3. The ferromanganese residue is dried and calcinated in an electric furnace and subsequently smelted.

Figure A.4.7.22 Sulphuric Leaching Flow Sheet

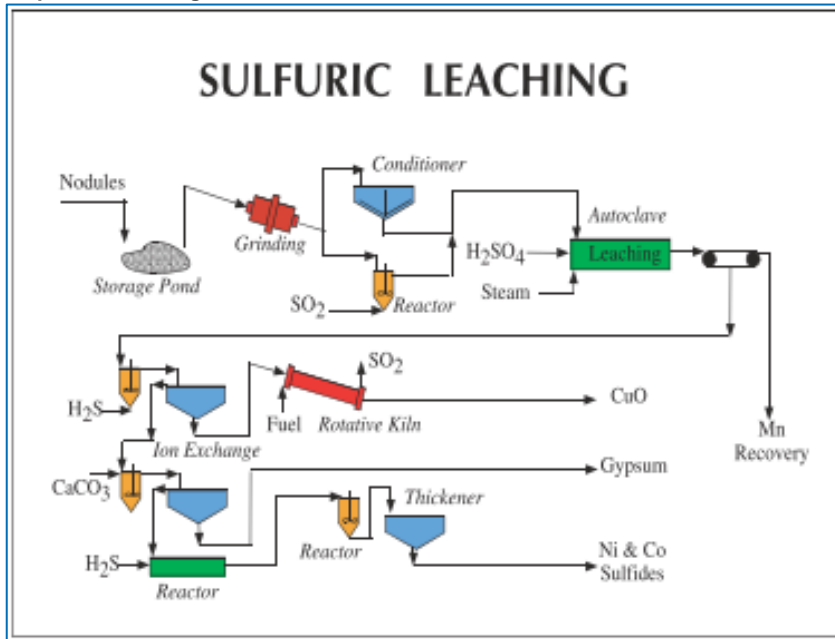

Source: International Seabed Authority, <http://www.isa.org/jm/en/home>.

Smelting

Classic nickel and copper smelting processes have been investigated as a method for polymetallic nodules processing. First the nodules are crushed dried and calcinated in a rotary kiln after which the material is fed into an electric furnace for reduction. The output of this electric furnace process is a manganese rich slag and an iron-nickel-copper-cobalt alloy.

The alloy is further processed in a converter (which removes most of the remaining manganese and iron) and subsequently, by adding sulphur a nickel-copper-cobalt matte is obtained. This matte can be processed in a refinery.

The manganese slag is fed directly to an electric-arc furnace to remove residual heavy metals and much of the iron. The final product is a ferro-silico-manganese alloy.

Figure A.4.7.23 Smelting Flow Sheet

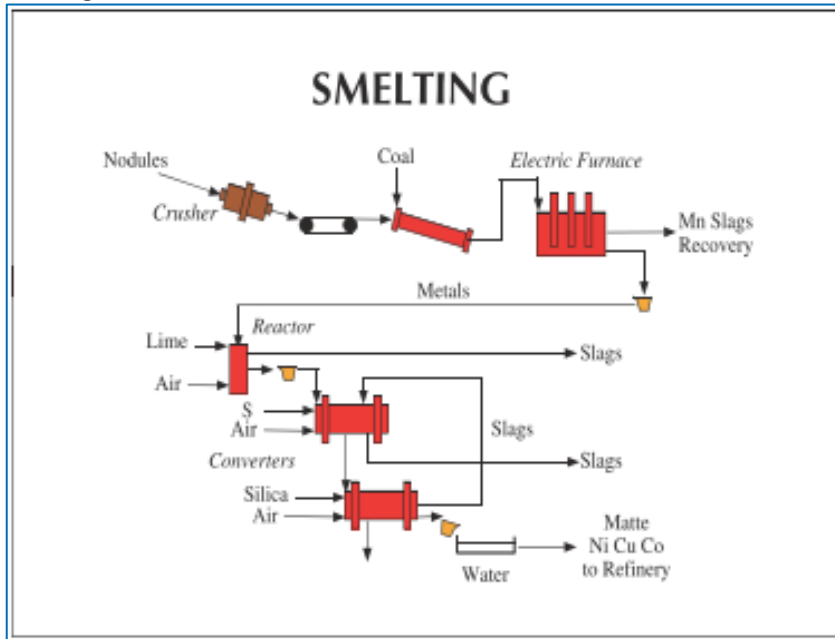

Source: International Seabed Authority, <http://www.isa.org/im/en/home>.

Technology readiness level

Technological Readiness Level

TRL - 1	TRL - 2	TRL - 3	TRL - 4	TRL - 5	TRL - 6	TRL - 7	TRL - 8	TRL - 9
---------	---------	---------	---------	---------	---------	---------	---------	---------

TRL 2 - technology concept formulated.

7.6.3 Cobalt-rich crusts

Cobalt-rich crusts are deposited as thin layers bonded to a substrate rock. This bonding together with the fact that cobalt-rich crusts are relatively thin, make it very likely that large amounts of substrate material are mined together with the ore. The valuable ore needs to be separated prior to mineral extraction. Because both crusts and nodules are ferromanganese oxides, metallurgical processing is expected to be similar.

Several small-scale research projects have been carried out in order to find the best method to separate the ore from the gangue^{60 61}. Flotation and JIG separation have been found to be appropriate separating methods and show recoveries between 89 and 94% whilst removing 62% of the feed weight when using flotation with particle sizes <600 micrometre⁶². Ito et al⁶³ estimate a recovery of 93% and purity of 86% whilst using JIGS and Flotation equipment simultaneously depending on grain size (see **Figure A.4.7.24**). Using the same techniques as for polymetallic nodules the concentrate product can be further processed to extract the metals.

⁶⁰ Ito et al. (2008). Estimation of degree of liberation in a coarse crushed product of cobalt-rich ferromanganese crust/nodules and its gravity separation. *International Journal of Mineral Processing*(87), 100-105.

⁶¹ Hirt et al. (1991). Flotation of cobalt-rich ferromanganese crust from the pacific ocean. *Minerals Engineering*, 4(5/6), 535-551.

⁶² Hirt et al. (1991). Flotation of cobalt-rich ferromanganese crust from the pacific ocean. *Minerals Engineering*, 4(5/6), 535-551.

⁶³ Ito et al. (2008). Estimation of degree of liberation in a coarse crushed product of cobalt-rich ferromanganese crust/nodules and its gravity separation. *International Journal of Mineral Processing*(87), 100-105.

The increased product quality of the ore concentrate and significant mass reduction make that this processing step could very well be implemented on board a support vessel/platform to reduce transport costs. Also, the waste material can immediately be transported back to the seafloor at the same spot where it was extracted.

Figure A.4.7.24 Process Flow Sheet Cobalt-rich Crusts

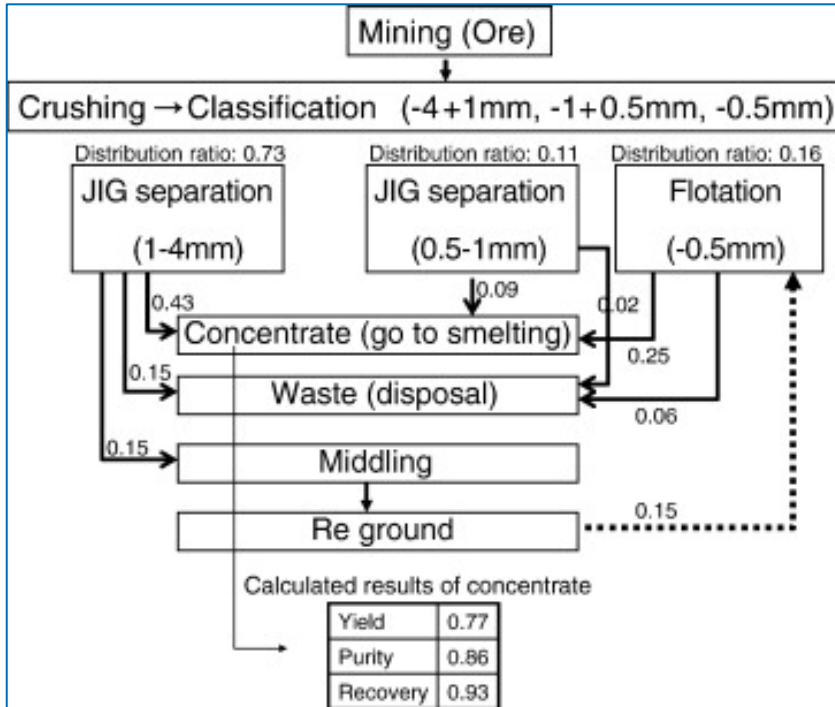

Source: Ito et al. (2008). Estimation of degree of liberation in a coarse crushed product of cobalt-rich ferromanganese crust/nodules and its gravity separation. International Journal of Mineral Processing(87), 100-105.

Technology readiness level

Technological Readiness Level

TRL - 1 **TRL - 2** TRL - 3 TRL - 4 TRL - 5 TRL - 6 TRL - 7 TRL - 8 TRL - 9

TRL 2 - technology concept formulated.

7.6.4 Overall likelihood of implementation

Due to size of the installations (pyro- and hydrometallurgy), high temperatures (pyrometallurgy), hazardous chemicals (hydrometallurgy), and large energy requirements (electrometallurgy), these techniques are either not possible or not very well feasible on a seagoing vessel or on a platform.

8 Ongoing EU research efforts

Several publicly funded research projects are being carried out on the national as well as the EU level related to deep-sea mining and deep-sea exploration. Research is often supported by engineering firms and technology providers themselves who work closely together with research institutes and universities. The table below lists the EU-wide research projects that are related to deep-sea activities and (partially) funded by the EU.

Table 8.1 Ongoing EU research projects

Project	Fund	Research scope
Blue Mining (2014-2018) http://www.bluemining.eu	FP7 (€15mio of which €10mio EC funded)	Blue Mining's aim is to develop all key technologies for exploration (discovery and assessment) and for exploitation of deep sea mineral resources up to TRL6, i.e. system/subsystem model or prototype demonstration in a relevant environment. Blue Mining will also prepare an exploitation plan for the next phases in the technology and business. Focus on Manganese nodules and seafloor massive sulphides
MIDAS (2013-2016) http://www.eu-midas.net	FP7 (€12mio of which €9mio EC funded)	MIDAS has a set of objectives, aimed at building the knowledge base to underpin sound environmental policies in relation to deep-sea exploitation: impact on ecosystems, solutions for socially acceptable commercial activities, cost-effective technologies for monitoring , best practice in international and national regulations. Focus on seafloor massive sulphides,REE, Gas hydrates.
HERMIONE (2009-2012) http://www.eu-hermione.net	FP7 (€9mio EC funded)	To investigate the dimensions, distribution and interconnection of deep-sea ecosystems; To understand changes in deep-sea ecosystems related to key factors including climate change, human impacts and the impact of large-scale episodic events; To understand the biological capacities and specific adaptations of deep-sea organisms, and investigate the importance of biodiversity in the functioning of deep-water

Project	Fund	Research scope
		ecosystems; To provide stakeholders and policy-makers with scientific knowledge to support deep-sea governance aimed at the sustainable management of resources and the conservation of ecosystems.
<p>HERMES (2004-2009) http://www.eu-hermes.net/intro.html</p>	FP6 (€15mio EC funded)	HERMES study sites extend from the Arctic to the Black Sea and include biodiversity hotspots such as cold seeps, cold-water coral mounds and reefs, canyons and anoxic environments, and communities found on open slopes. These important systems were chosen as a focus for research due to their possible biological fragility, unique genetic resources, global relevance to carbon cycling and susceptibility to global change and human impact.
<p>Deep-Sea and Sub-Seafloor Frontier (DS3F) (2010-2012) http://www.deep-sea-frontier.eu/</p>	FP7	The 'Deep-sea and sub-seafloor frontier' (DS3F) project brings together scientists from Europe's major ocean research centres and universities to identify the primary issues that need to be addressed in sub-seafloor sampling with relevance to deep-sea ecosystems, climate change, geohazards, and marine resources in the next 10-15 years. It is aiming to provide a pathway towards sustainable management of oceanic resources in the broadest sense on a European scale and to develop sub-seafloor sampling strategies for enhanced understanding of deep-sea and sub-seafloor processes by connecting marine research in life and geosciences, climate and environmental change, with socio-economic issues and policy building.
<p>ECORD, the European Consortium for Ocean Research Drilling. As part the Integrated Ocean Drilling Program - IODP and from 2013 onwards International Ocean Discovery Program (IODP) "Exploring the Earth under the sea". (2003-date)</p>	Through ECORD-membership, ECORD funds mission specific platform operations	The International Ocean Discovery Program (IODP) is an international marine research collaboration that explores Earth's history and dynamics using ocean-going research platforms to recover data recorded in seafloor sediments and rocks and to monitor subsea floor environments. IODP depends on facilities funded by three

Project	Fund	Research scope
http://www.ecord.org/about/aboutecord.html		platform providers with financial contributions from five additional partner agencies. Together, these entities represent 26 nations whose scientists are selected to staff IODP research expeditions conducted throughout the world's oceans.
EMSO (European Multidisciplinary Seafloor Observatory) as part of ESFRI (the European Strategy Forum on Research Infrastructures) http://www.emso-eu.org/	Through MS (national programmes), EC (FP7), EIB.	The European network of seafloor observatories (cabled & acoustically linked), constituting a distributed infrastructure for long-term (mainly) real-time monitoring of environmental processes related to ecosystems, global changes and geo-hazards to study also the interactions between geo-, bio- and hydro-sphere

From the above list, the projects of Blue Mining and MIDAS are specifically focused on deep-sea resource extraction. Blue Mining explores the needs for developing the technologies required for nodule and seafloor massive sulphides mining, while MIDAS focuses on environmental impacts from deep-sea activities. The remaining research efforts are linked with deep-sea mining, but have a wider scope.

In all of the projects above, national research institutes, universities and commercial companies play all a major role. The current state-of-play of deep-sea mining requires additional research and development efforts before commercial activities can be performed. This means that cooperation between actors and researchers will remain important.



P.O. Box 4175
3006 AD Rotterdam
The Netherlands

Watermanweg 44
3067 GG Rotterdam
The Netherlands

T +31 (0)10 453 88 00
F +31 (0)10 453 07 68
E netherlands@ecorys.com

W www.ecorys.com

Sound analysis, inspiring ideas